

PDF 2. DOCUMENTACIÓ GRÀFICA

Projecte Tècnic

24_06_PVM

**Substitució de les baranes de la
passarel·la central i el límit
perimetral de la necròpolis de la
plaça de la Vila de Madrid**

Districte de Ciutat Vella
08002
Barcelona

11 de Novembre de 2025

PROMOTOR
FOMENT DE CIUTAT

ARQUITECTE
Carles Esquerra Julià

DOMICILI FISCAL
CARRER DEL PINTOR FORTUNY, NUM 17,
08001 BARCELONA - (BARCELONA)

ÍNDEX

SITUACIÓ	
EMPLAÇAMENT	SI.100
ORTOFOTO	SI.101
ESTAT ACTUAL	SI.102
FOTOGRAFIES ESTAT ACTUAL	SI.103
ALÇADES DE CAIGUDA	SI.104
TIPOLOGIES DE BARANA ACTUAL	SI.105
PATOLOGIES DE LES BARANES ACTUALS	SI.106
ARQUITECTURA	
BARANA 90cm SIMPLE	AR.101
BARANA 90cm LLUMINARIA	AR.104
BARANA 110cm	AR.108
TIPOLOGIES DE BARANA PROPOSADES	AR.110
TIPOLOGIES ESPECIALS	AR.111
ESTUDI DE PERMEABILITAT VISUAL	AR.115
INSTAL·LACIONS	
ENLLUMENAT	IN.101





REVISIÓ	NÚM.	NOTES





REVISIÓ	NÚM.	NOTES



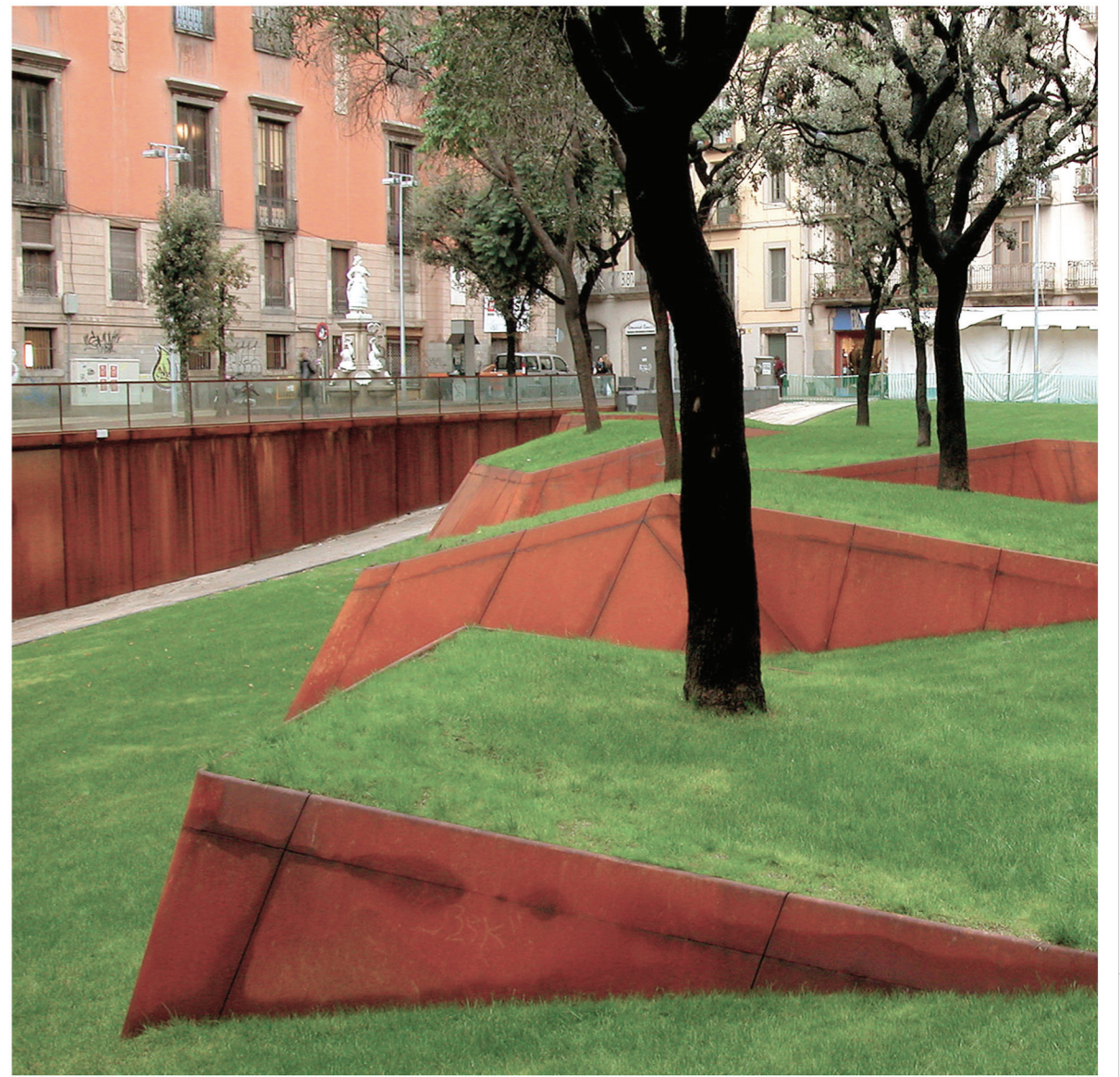



L'altura de caiguda no supera en cap cas els 6m, tampoc els 4m que demanen els serveis d'Infraestructures de l'Ajuntament de Barcelona.

Per tant, l'altura requerida de la barana és de 90cm.

Tot i així, l'estat actual, així com el projecte original contenen baranes de dues altures diferents. Aquest fet respon a una decisió de projecte (els encontres amb altres elements ja estan dissenyats així), fet pel qual es decideix mantenir aquesta decisió i entendre que la barana tindrà dues variants, amb altures de 90 i 110cm



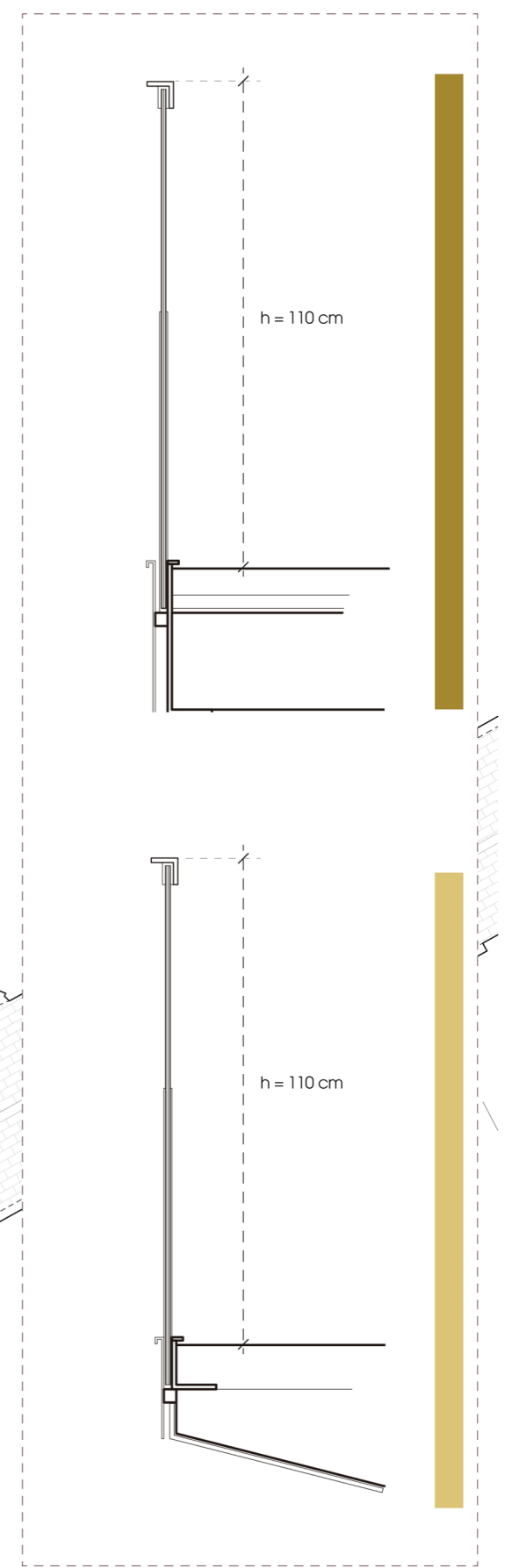
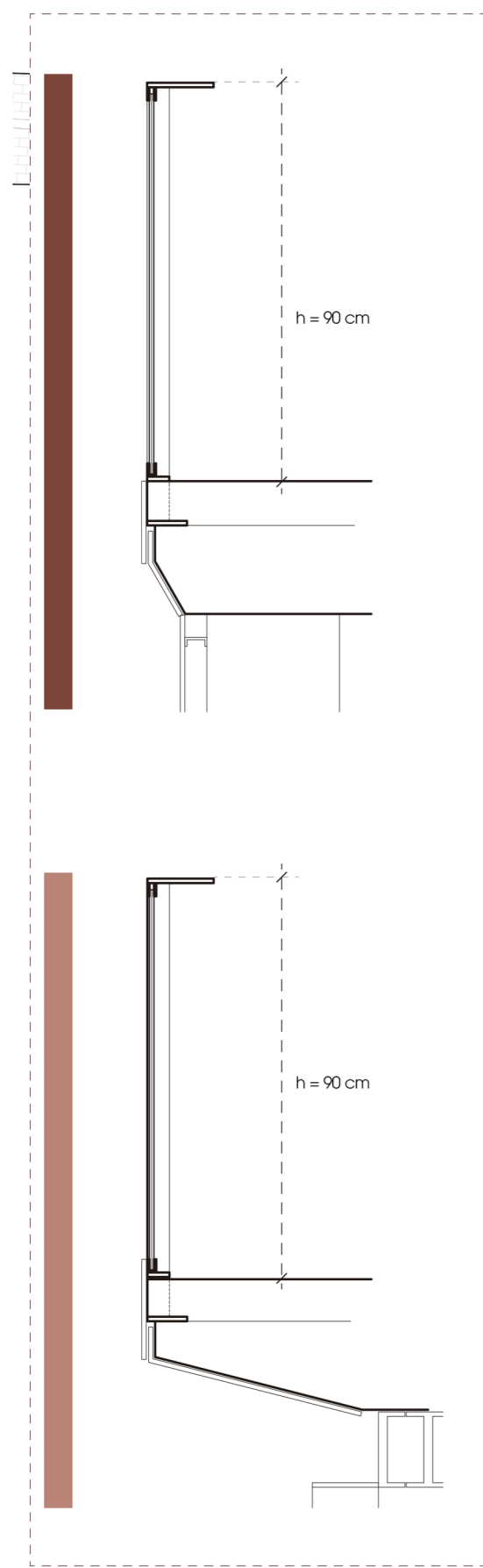

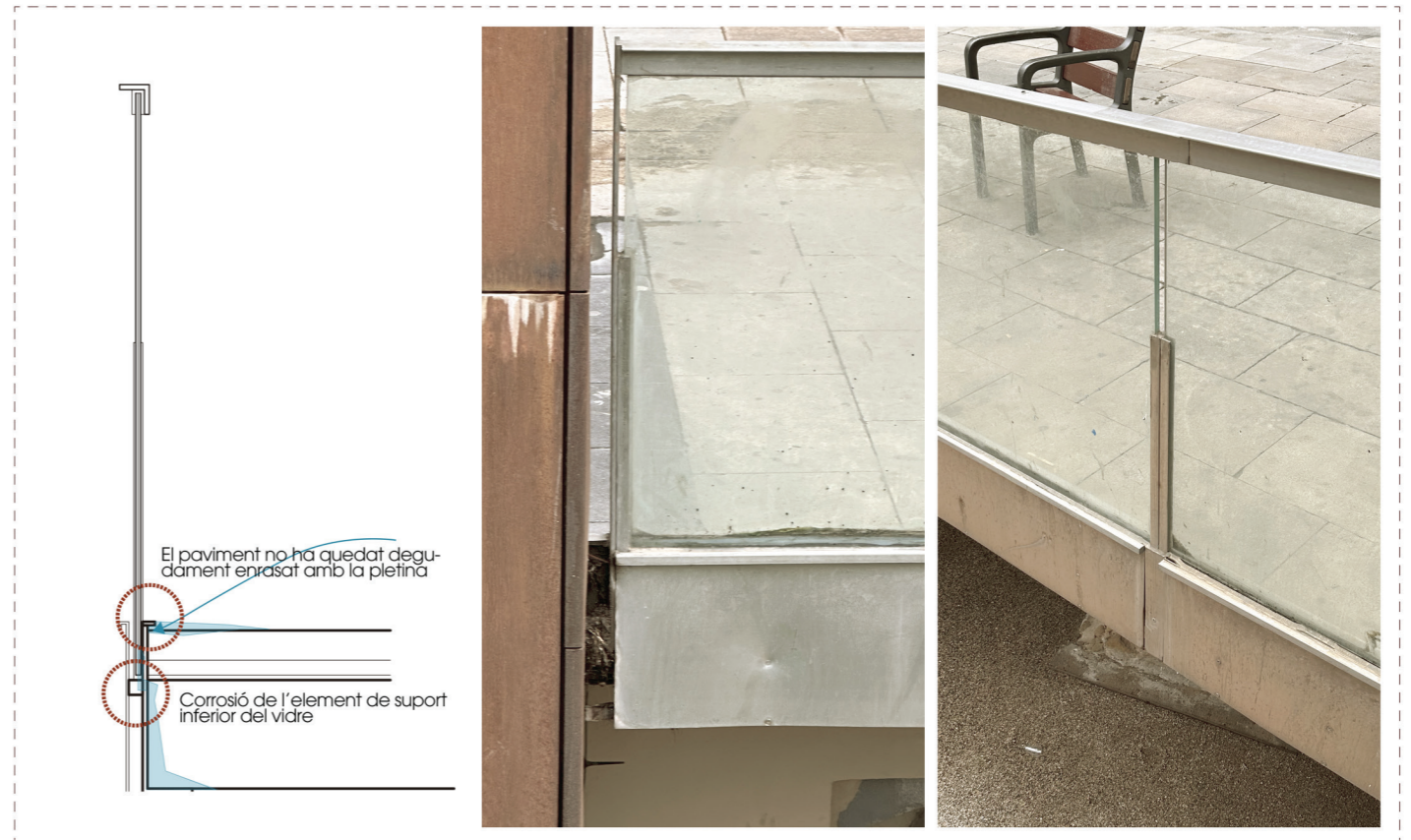
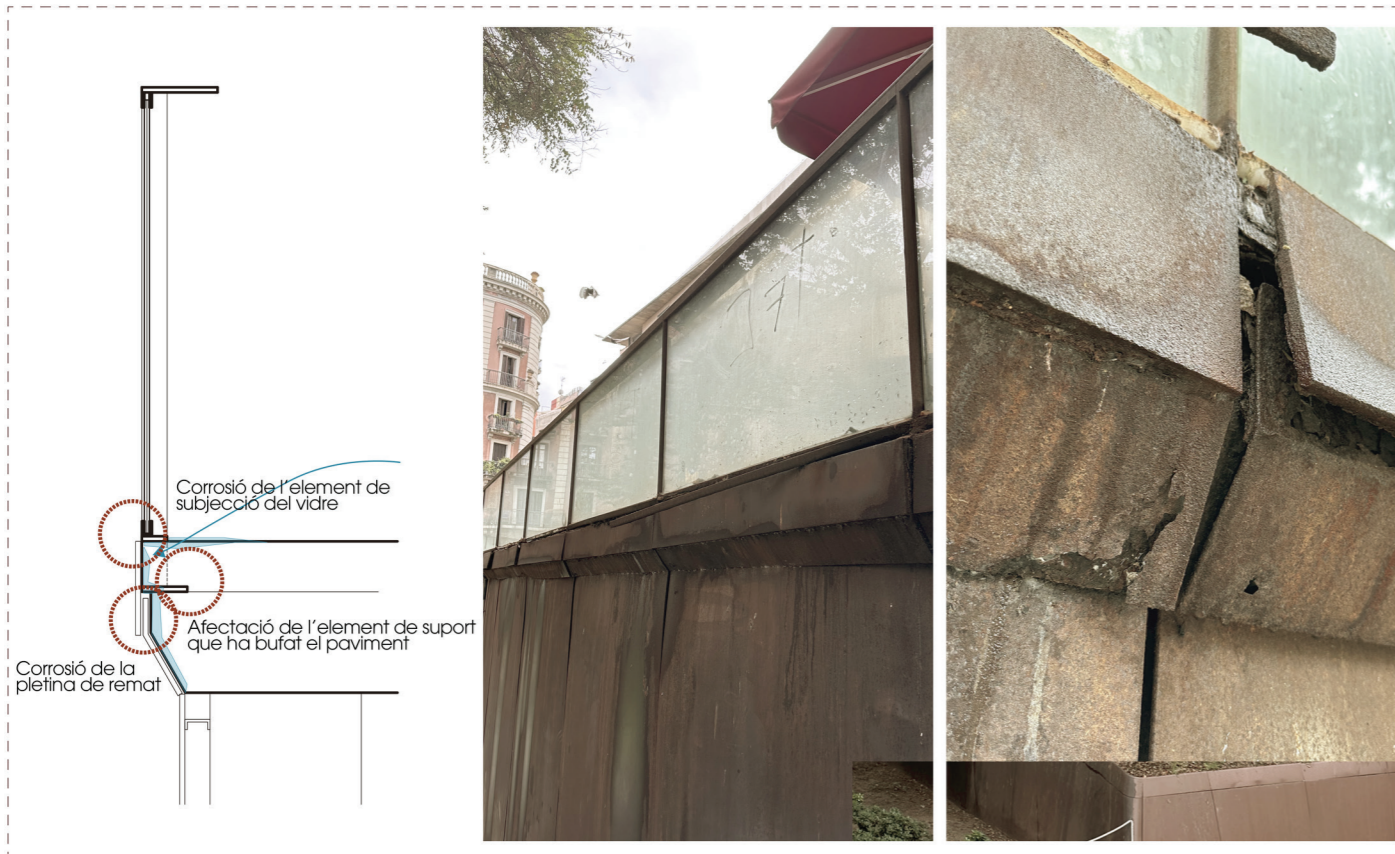

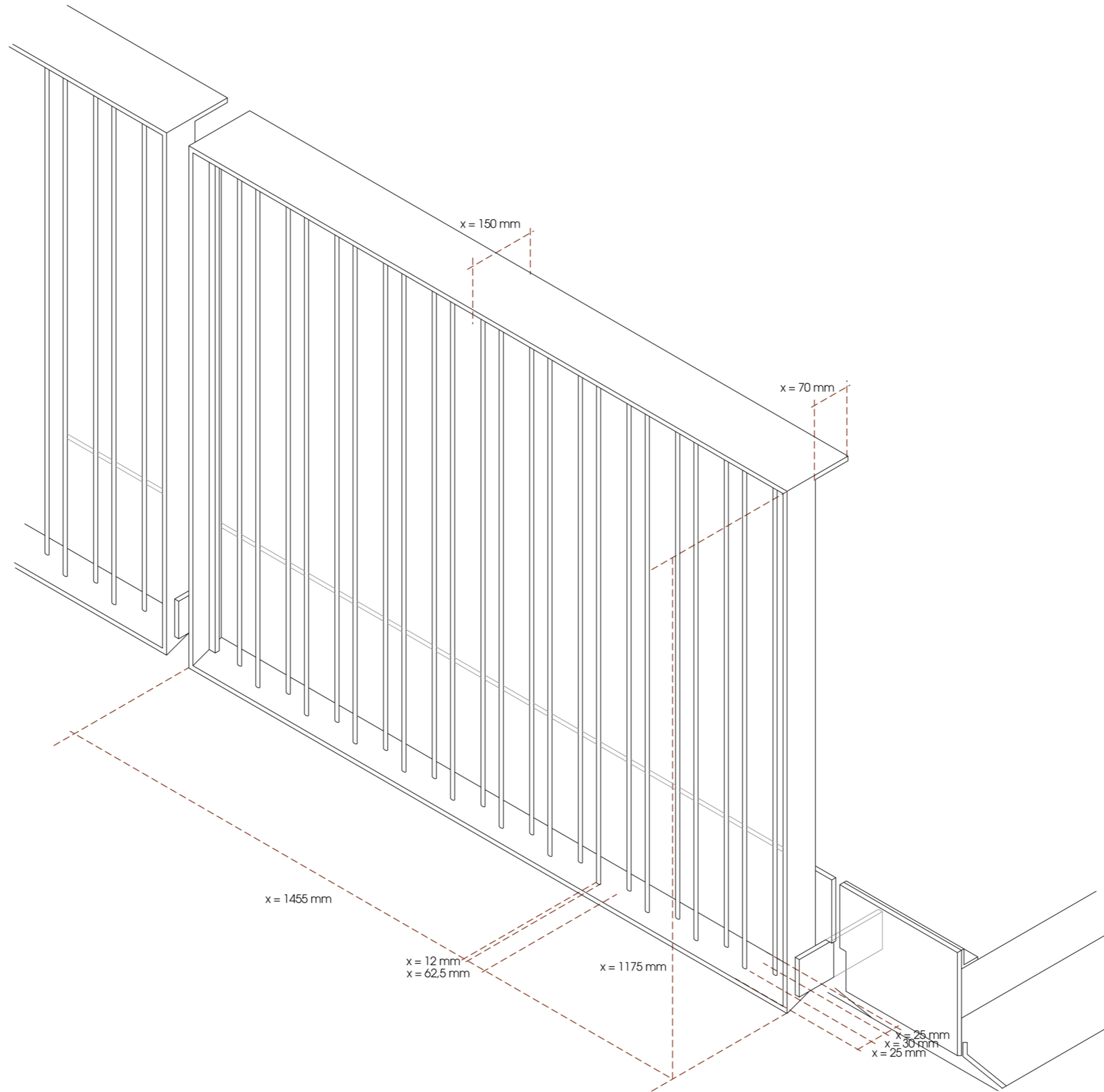

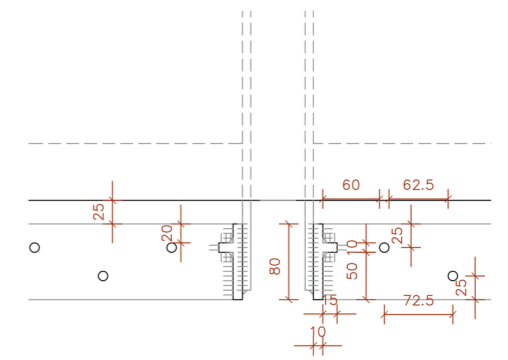
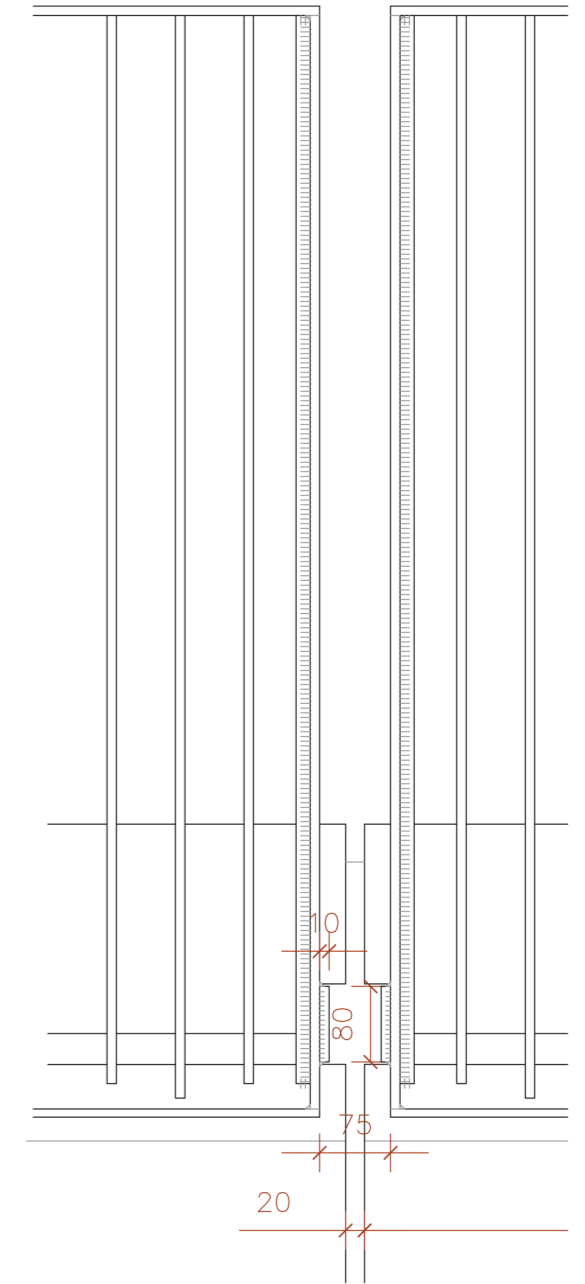
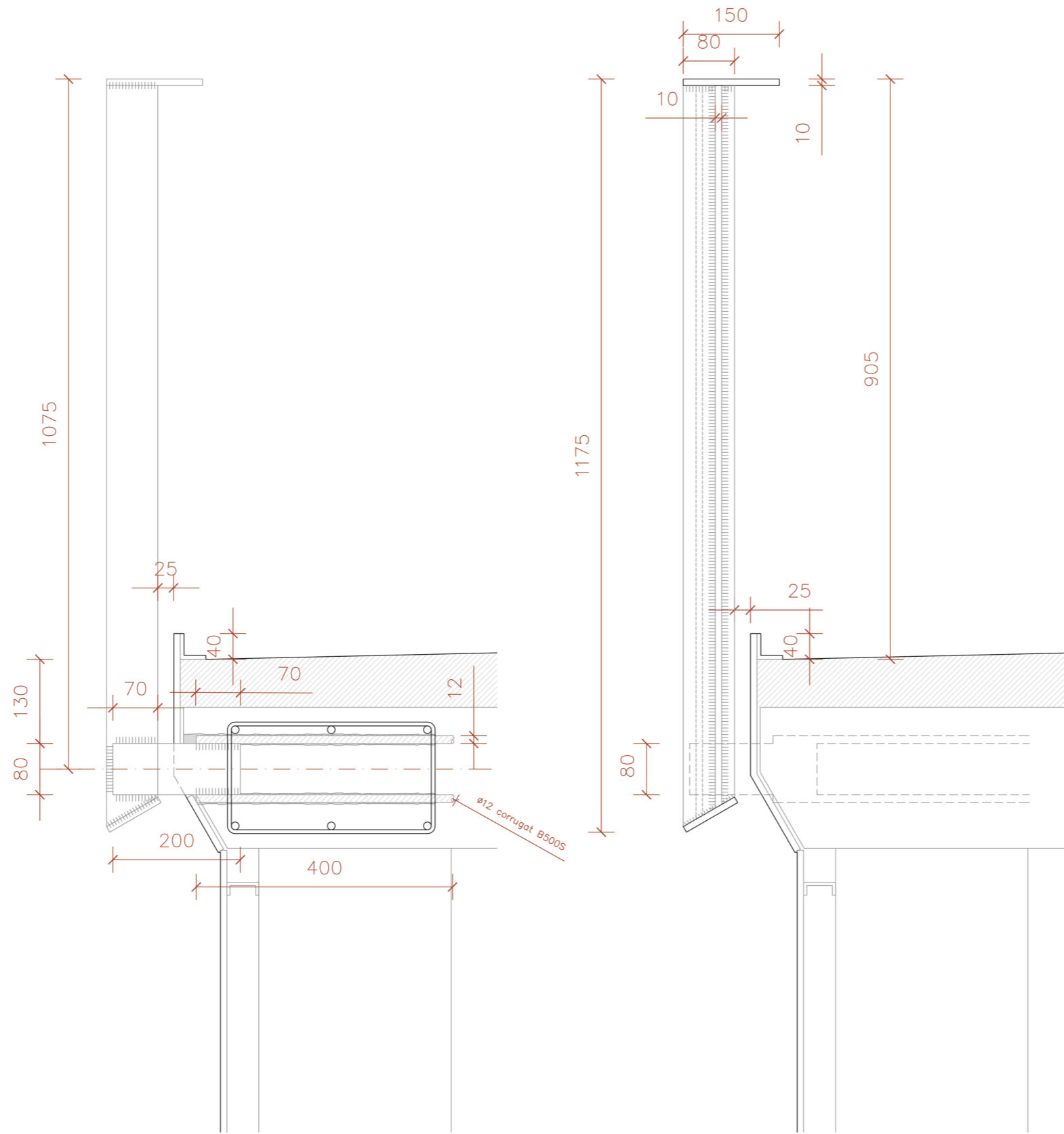

sòlid a topall amb penetració total (preparació de vores)
 cordó de 7mm de coll amb electrode E7018
 Ø12 corrugat B500S



7,5 cm 145,5 cm 7,5 cm

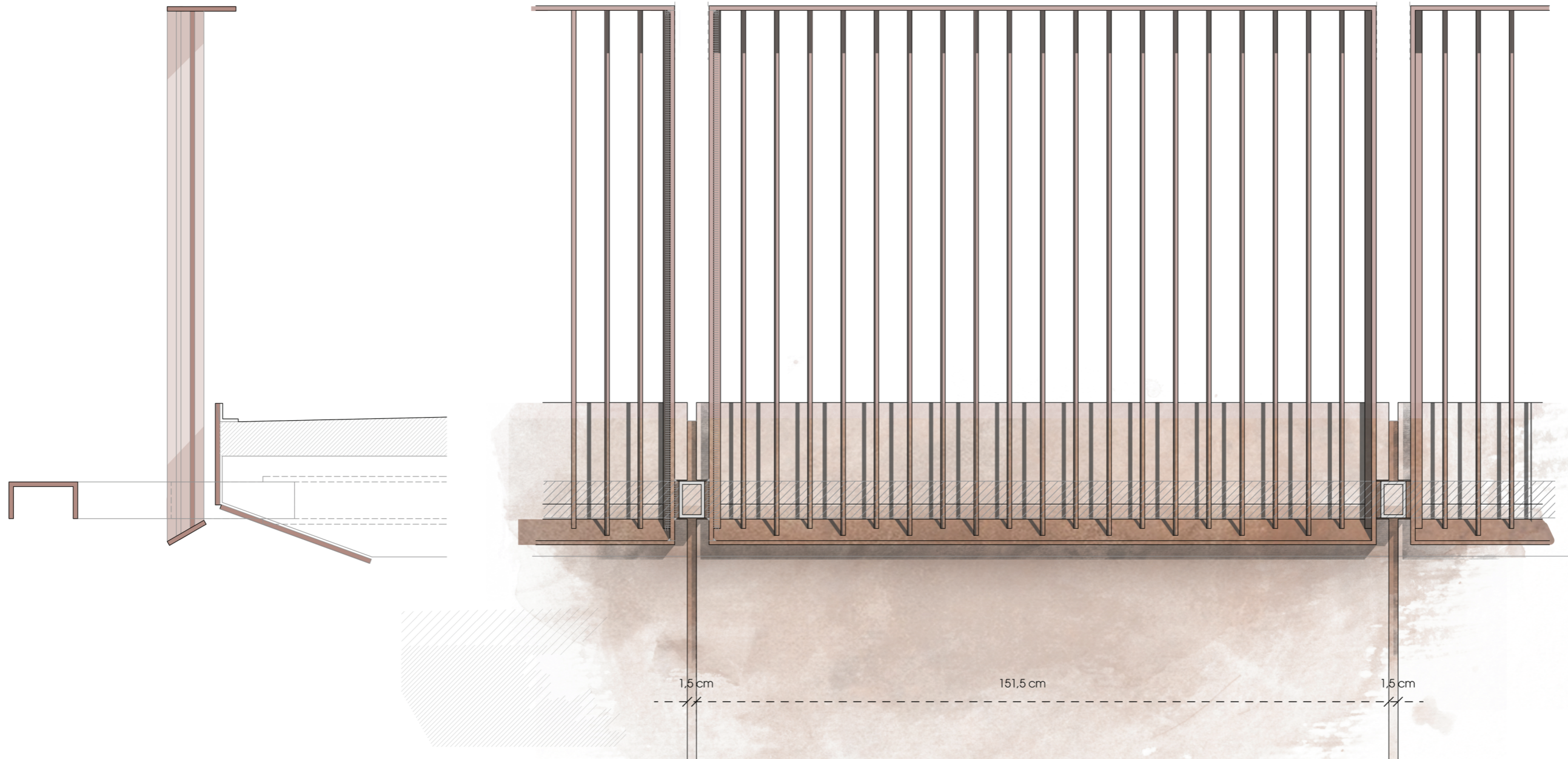

1,5 cm 151,5 cm 1,5 cm

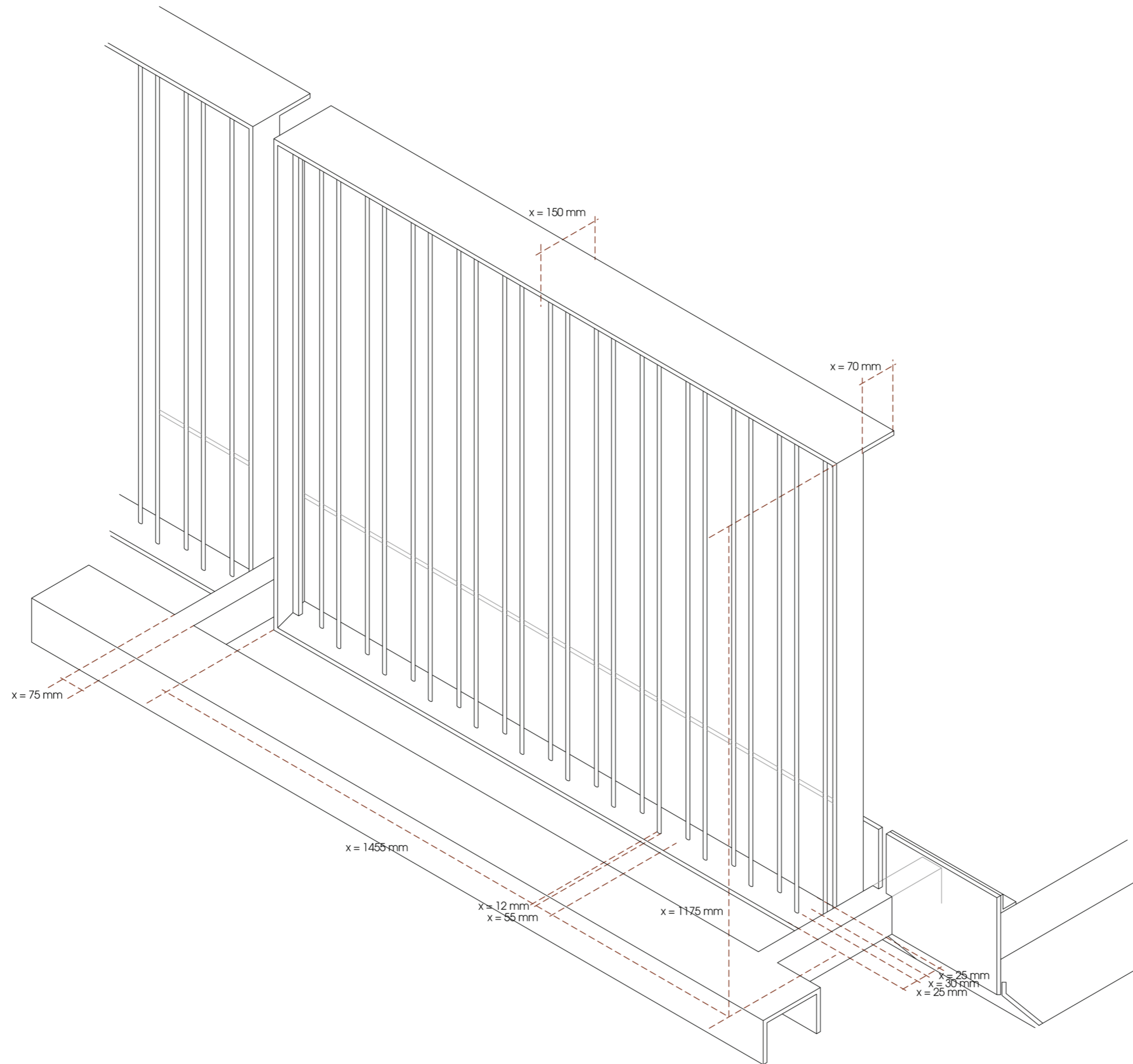

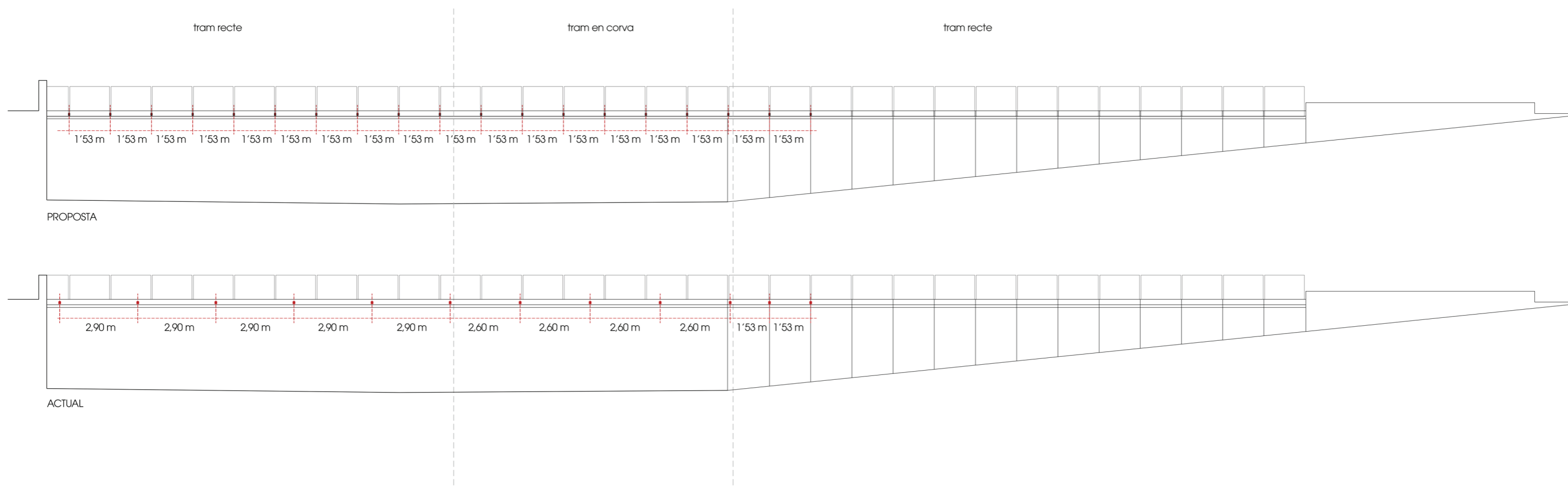

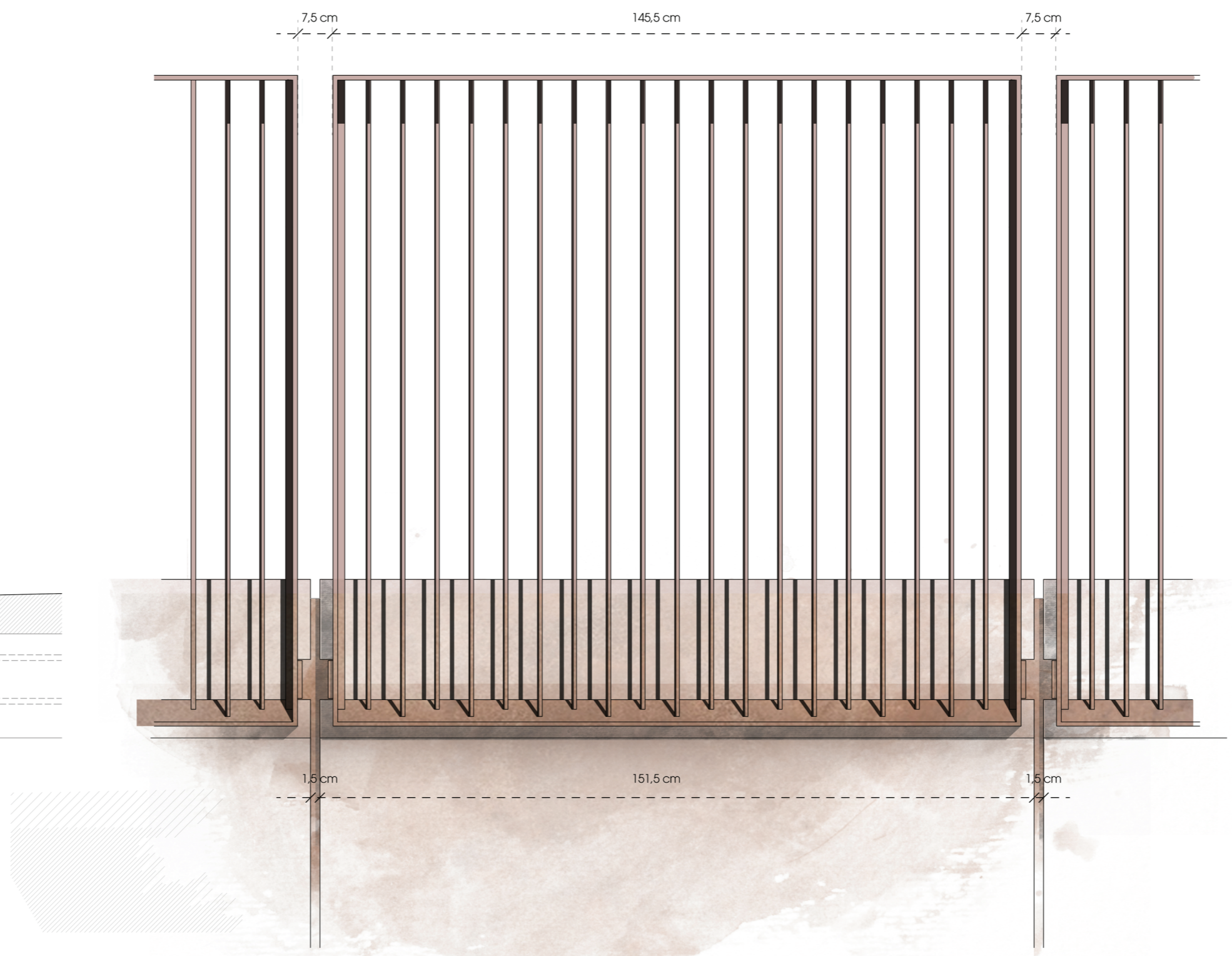
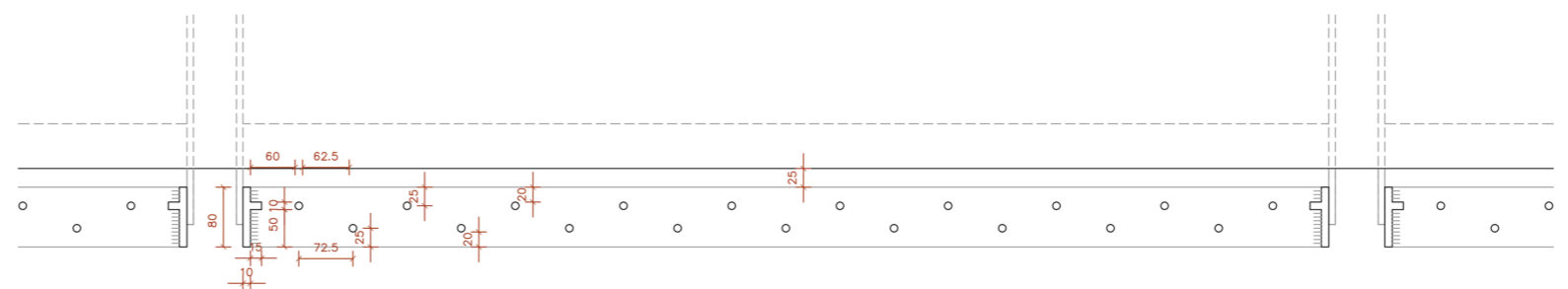
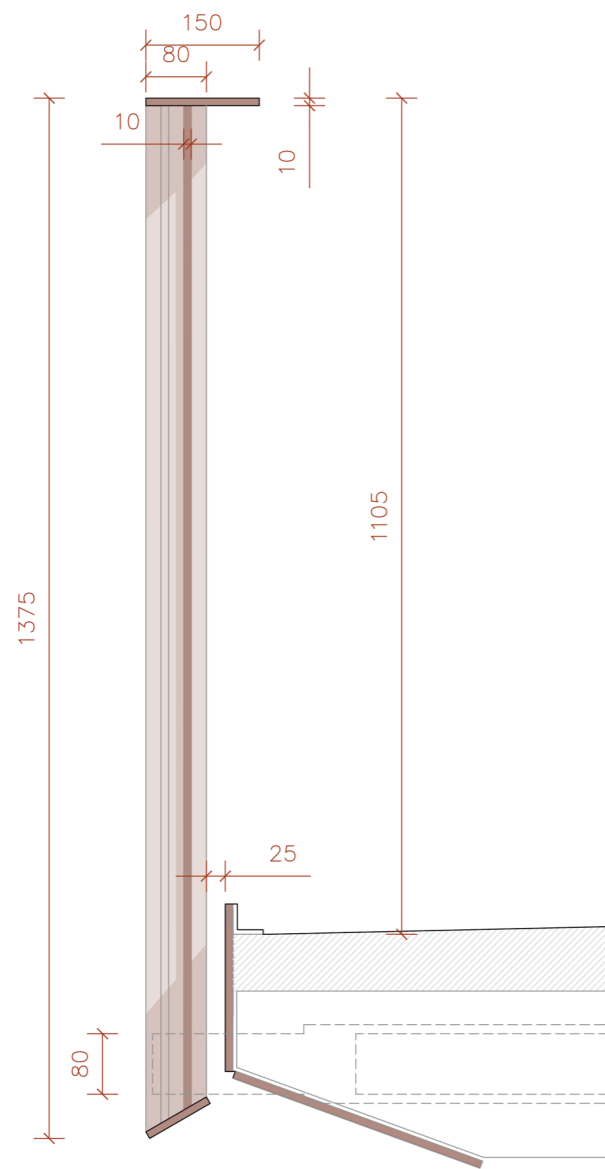



- BARANA 90cm SIMPLE (1-14) 14 unitats
- BARANA 90cm AMB LLUMINÀRIA (15-30) 16 unitats
- BARANA 110cm SIMPLE (33-49) 17 unitats
- BARANA 110cm AMB PLETINA GRAN (51-75,78,79) 27 unitats





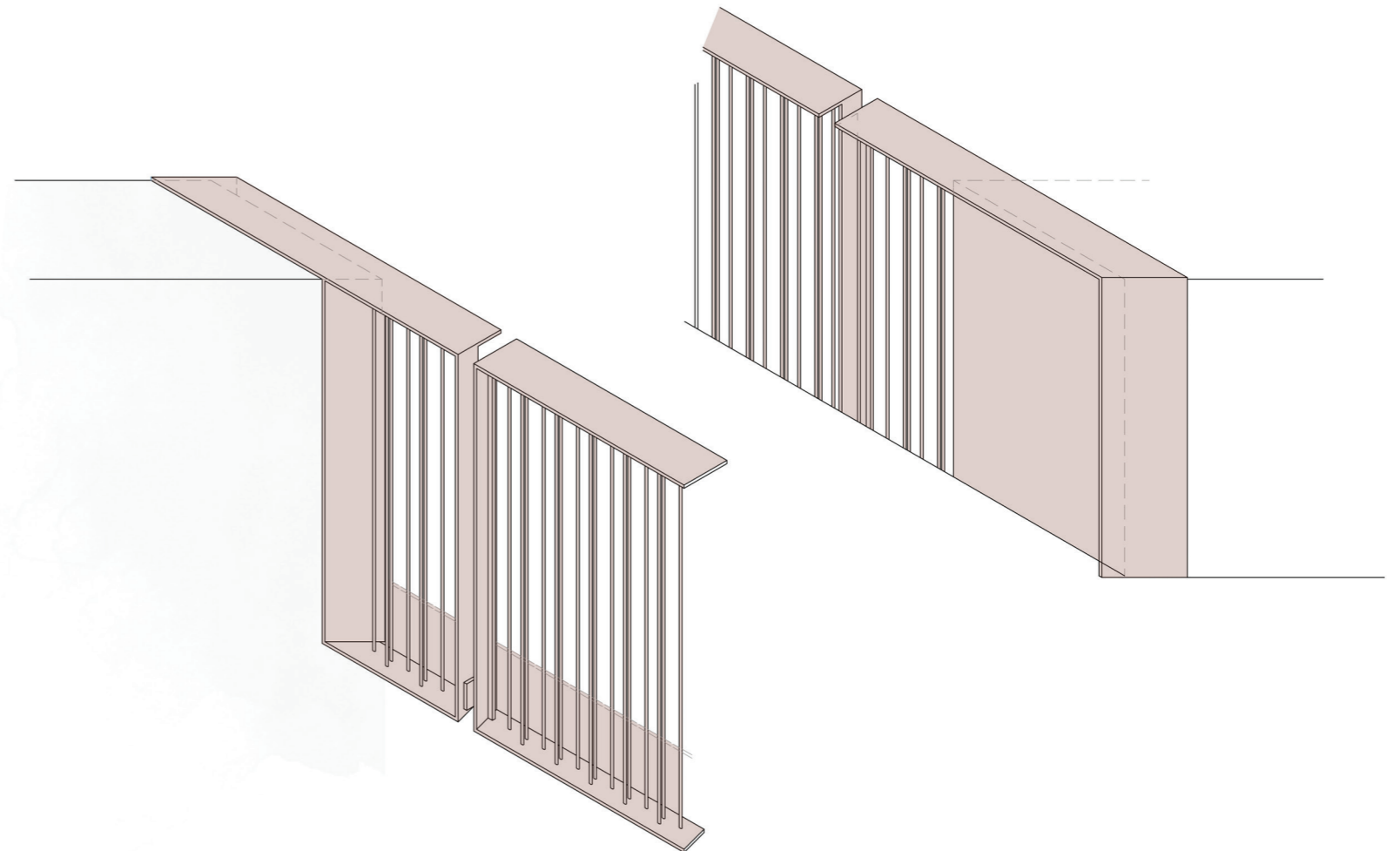
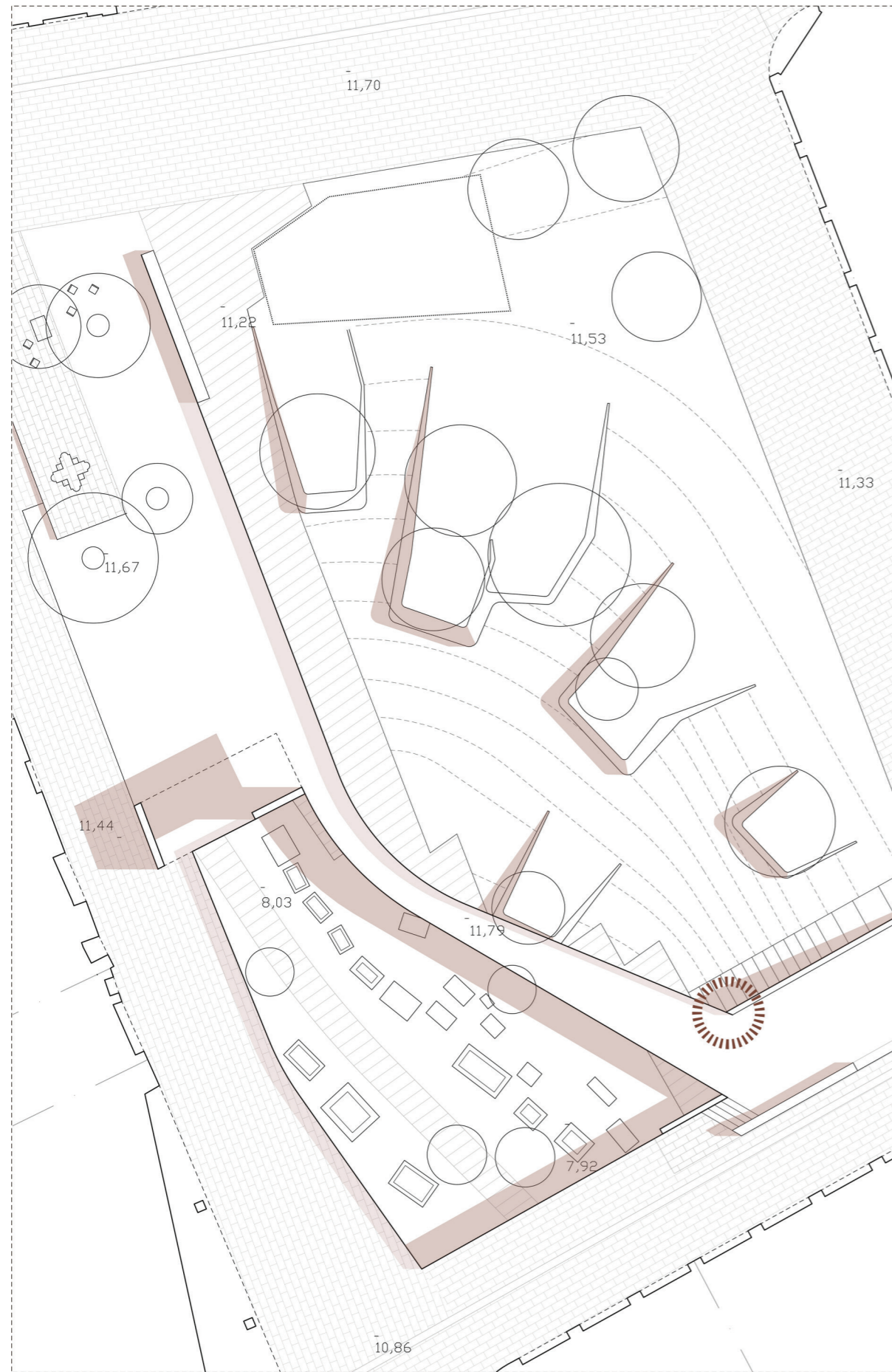

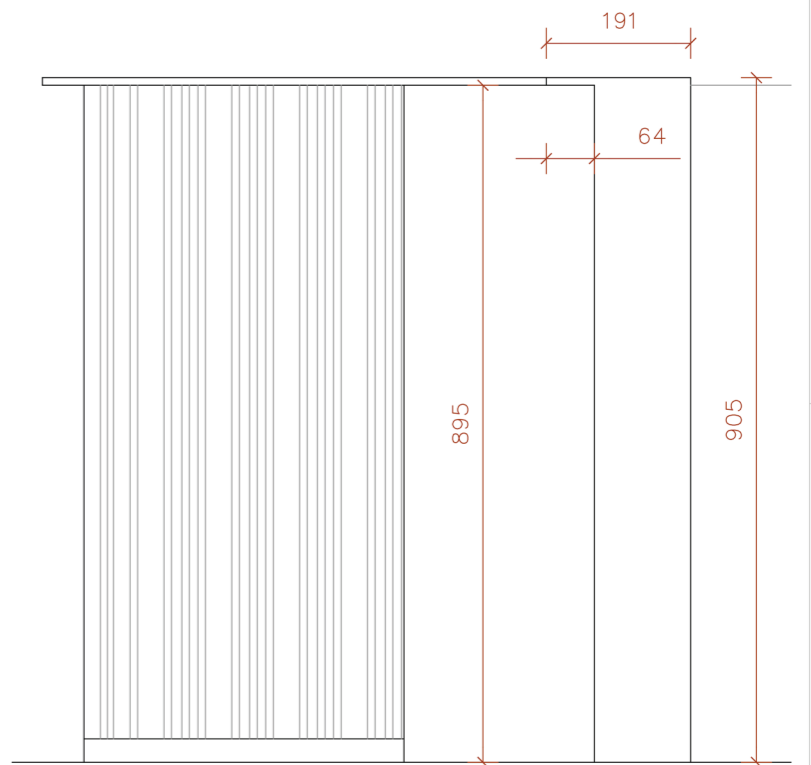
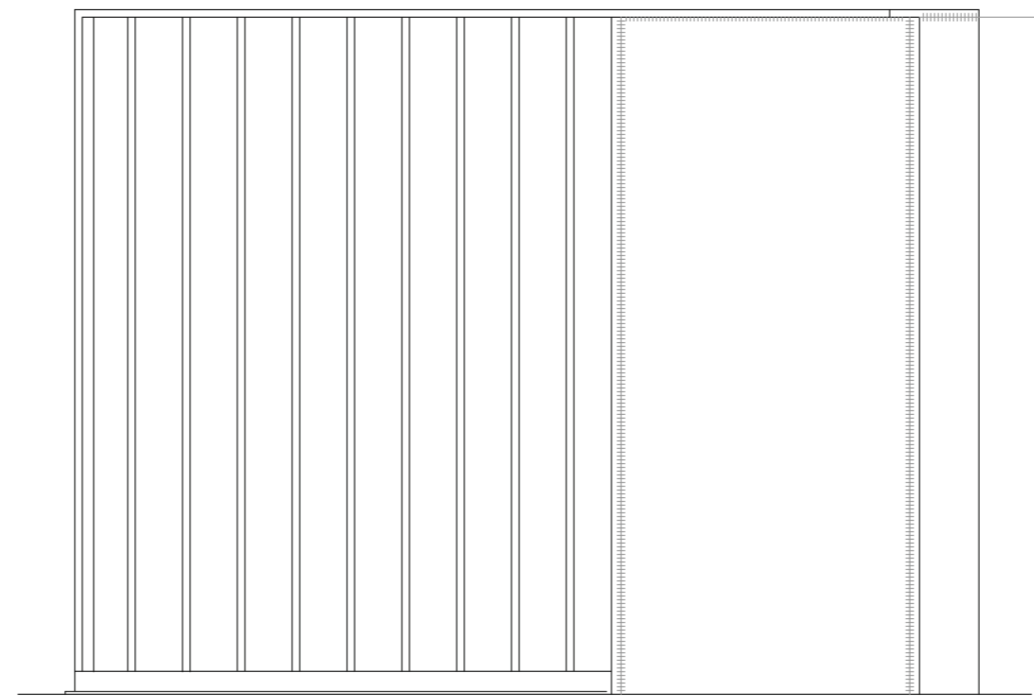
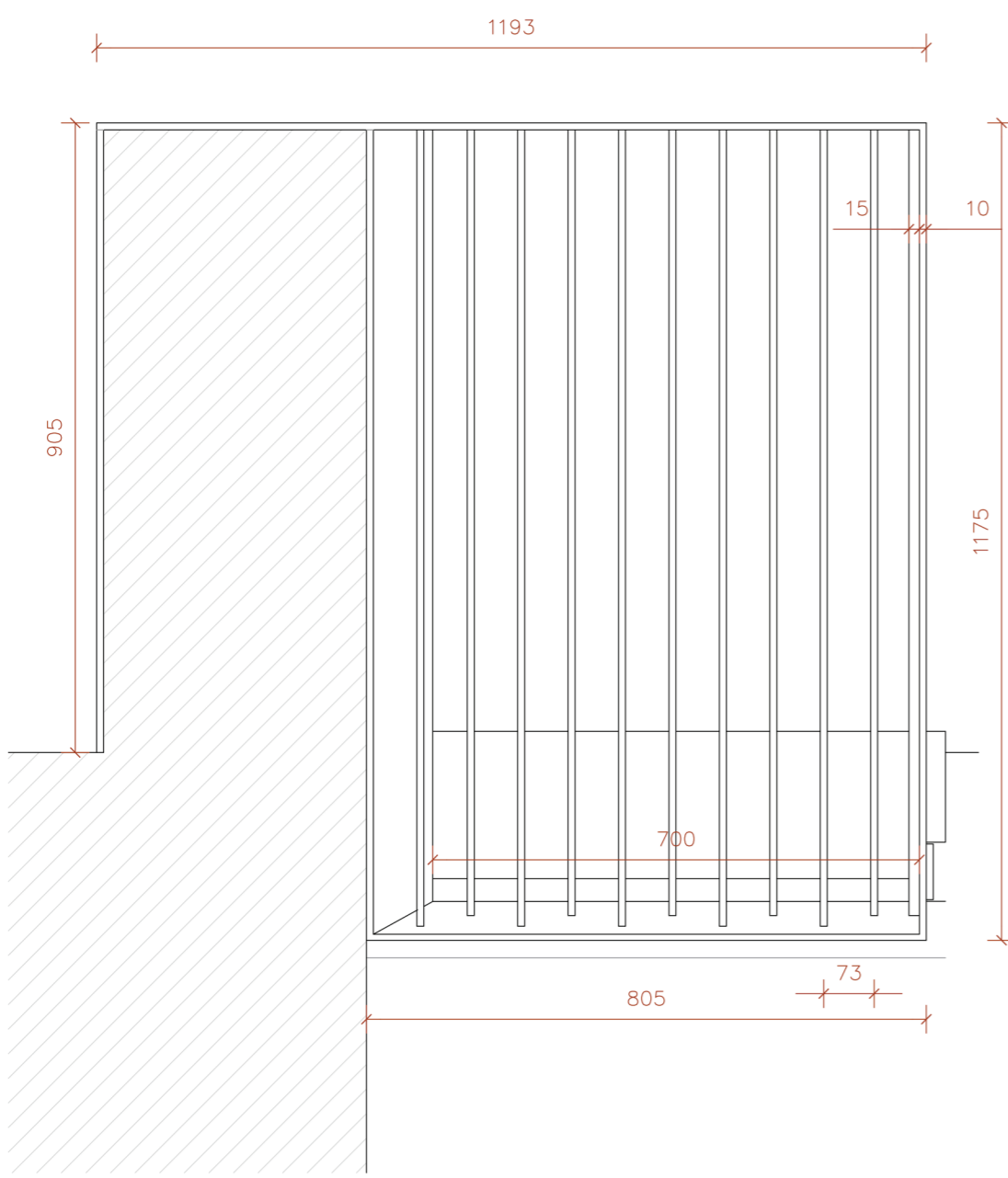
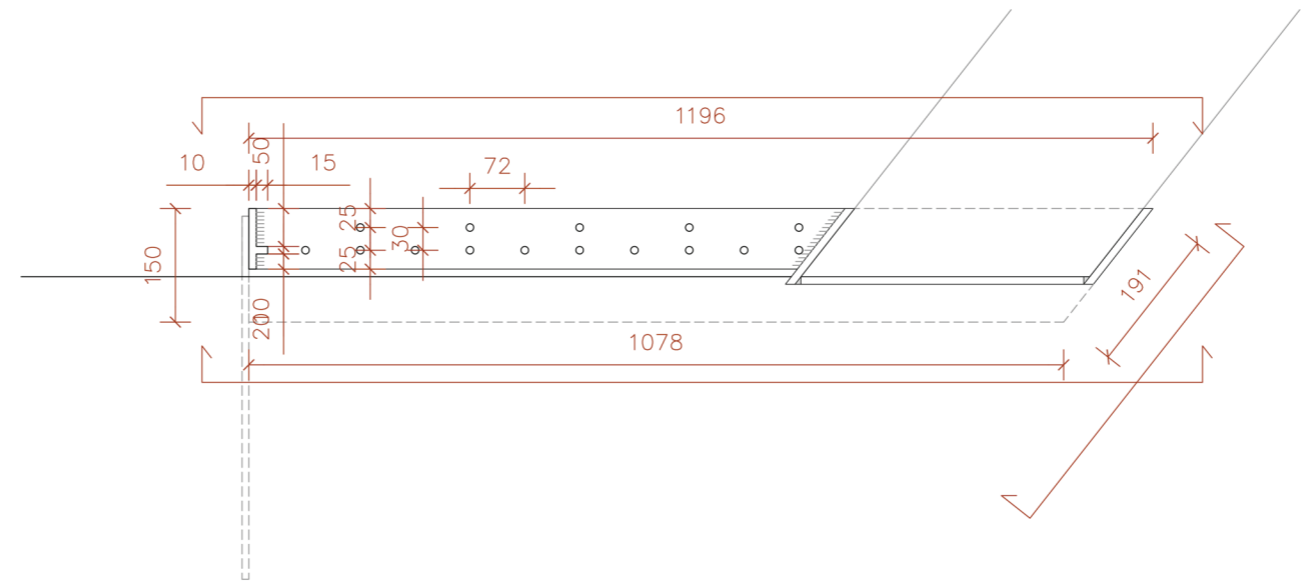

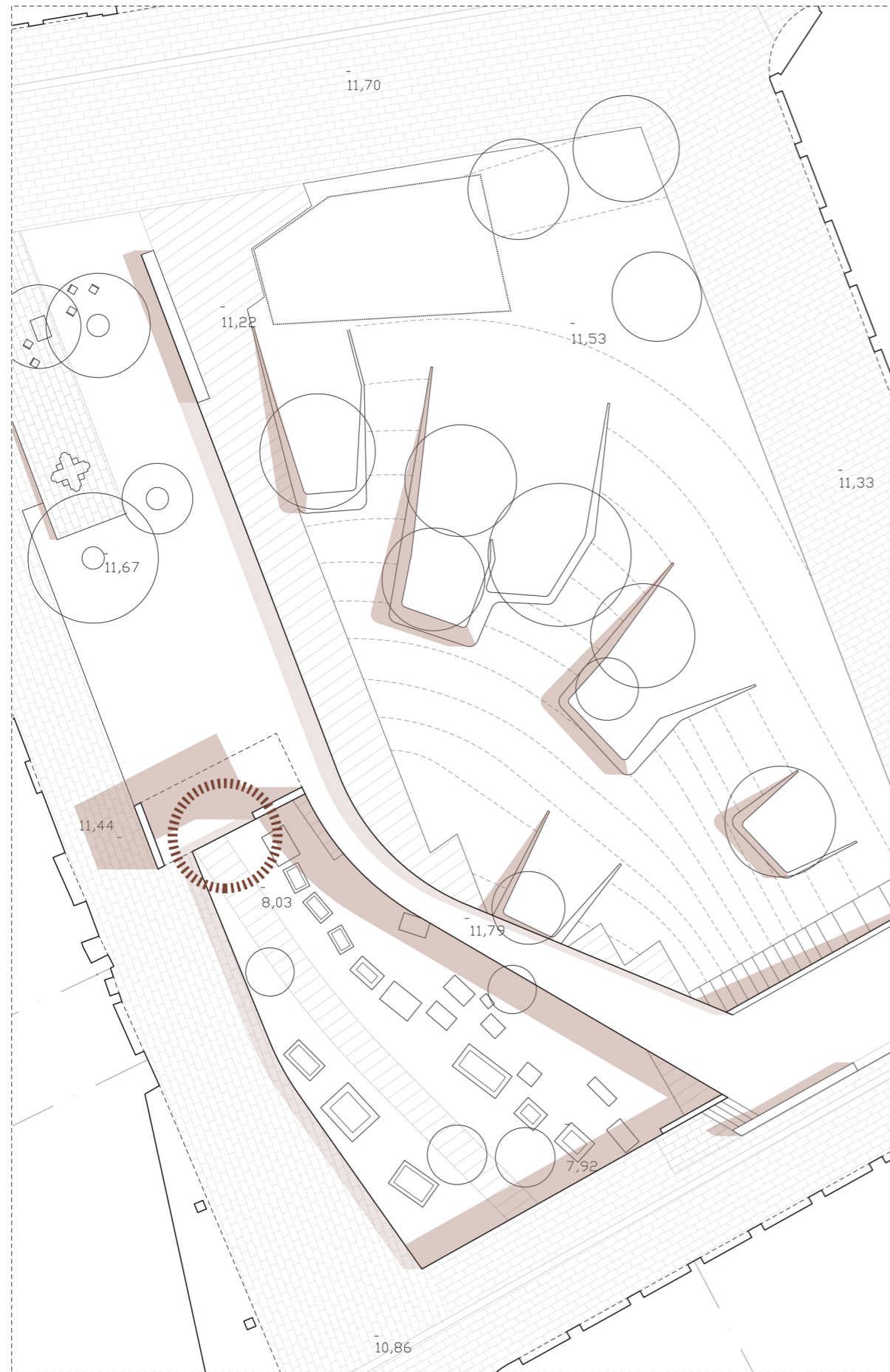

TIPOLOGIA DE 110cm AMB PLETINA GRAN
MODIFICACIÓ EN ANGLE

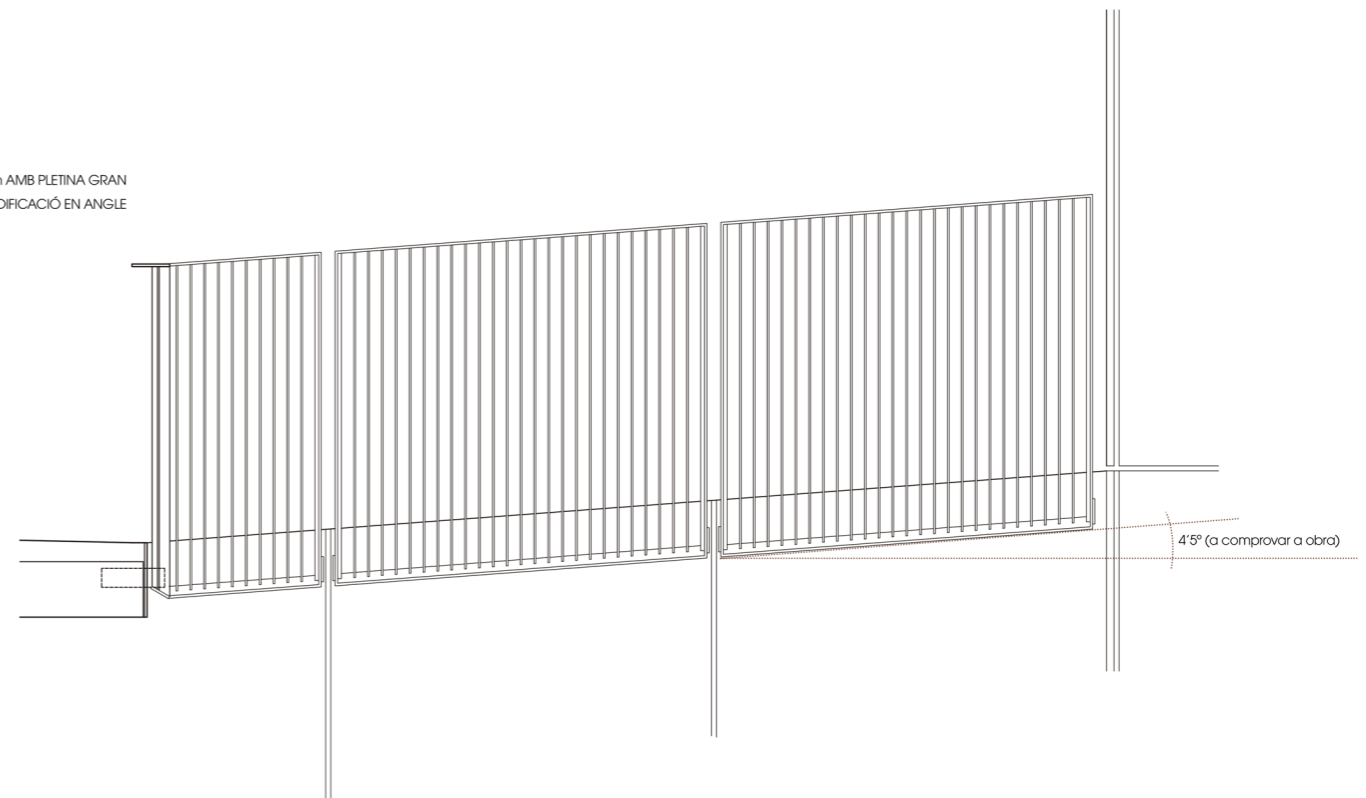

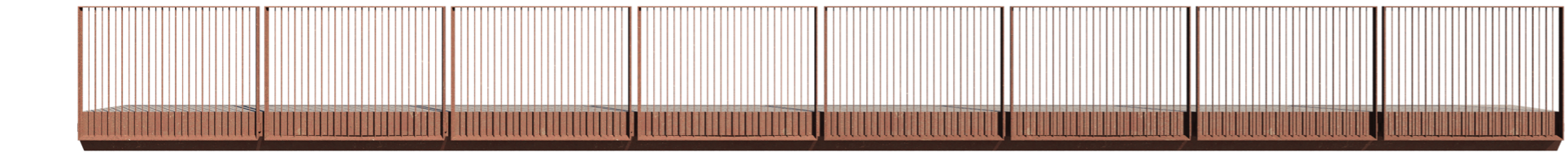

90°

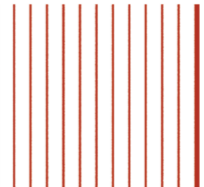

60°

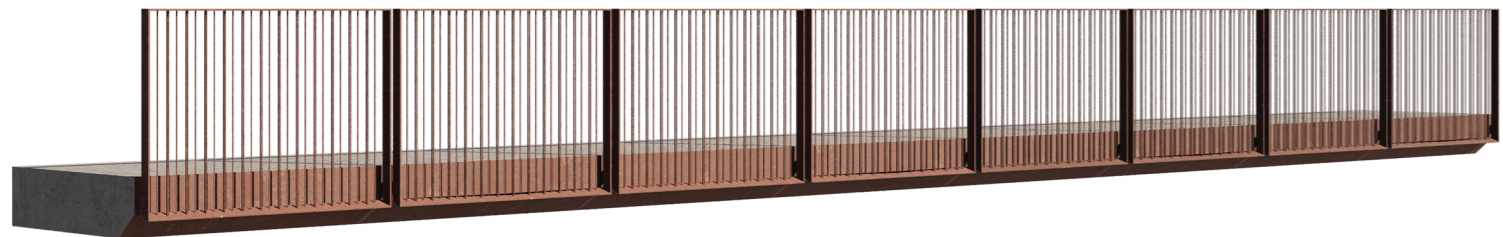

45°

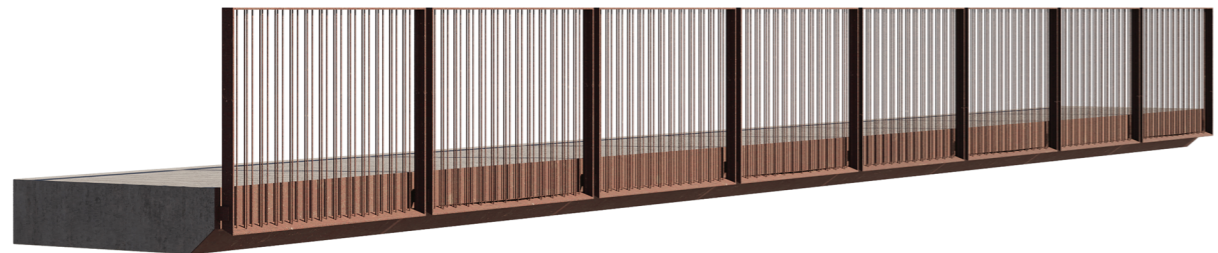
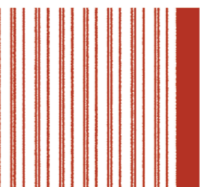

30°



15°

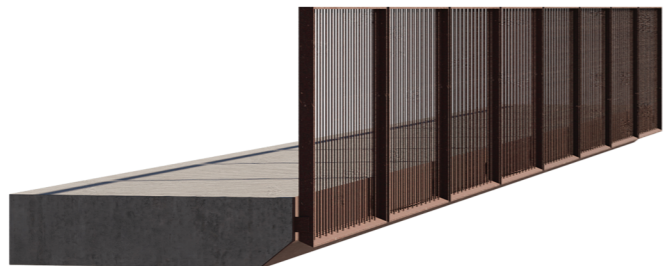
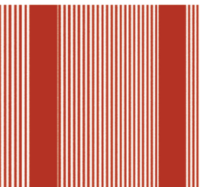

10°

