

Studio Animal

X

**DHHub** Disseny Hub  
Barcelona

# L'OCEÀ PARLA

Abril 2024

1. PLANIMETRÍA GENERAL
2. SISTEMA EXPOSITIVO
3. CORTINAS
4. PLANIMETRÍA: OTROS

# I. PLANIMETRÍA GENERAL

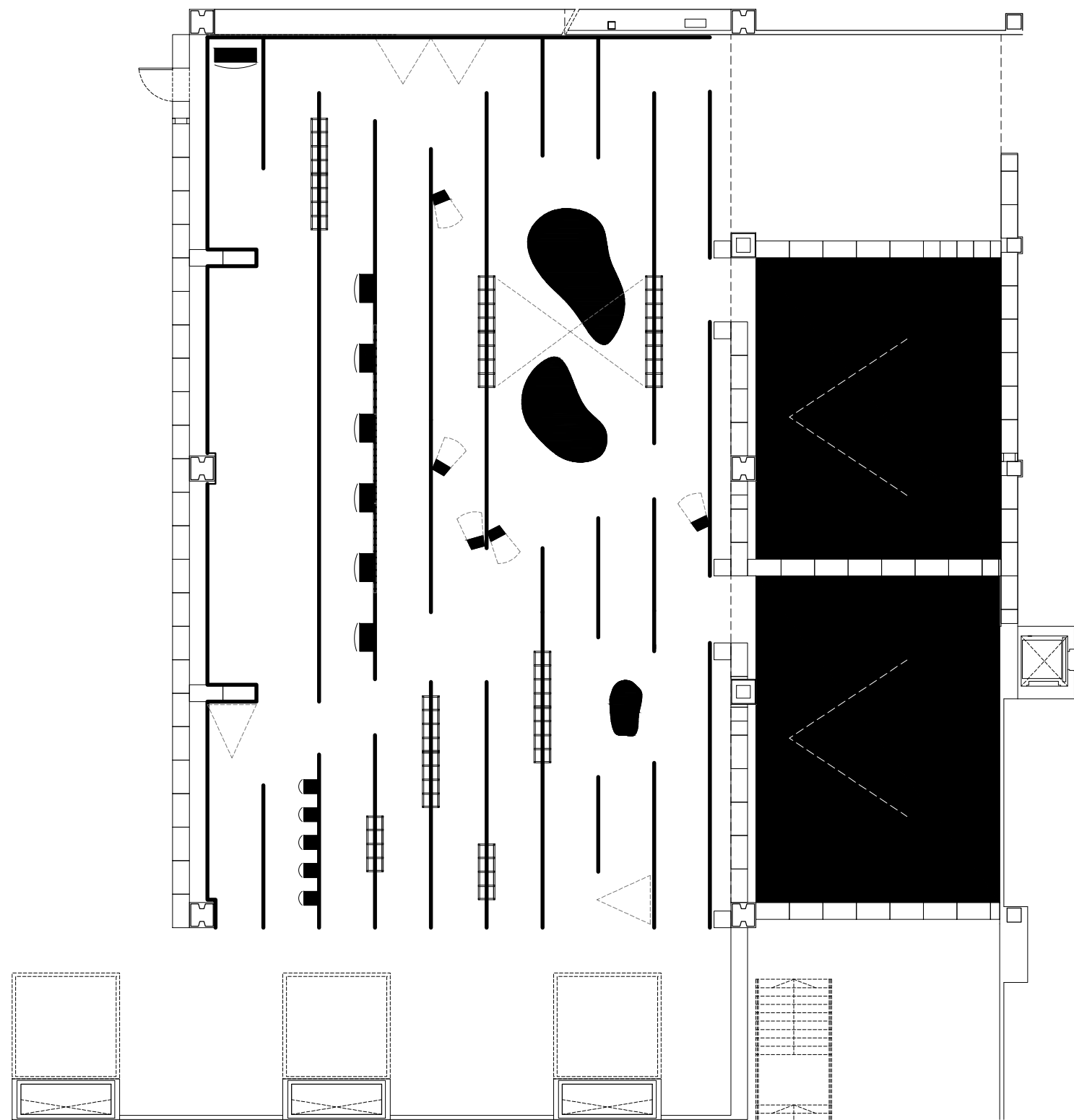

PLANTA BASE  
PLANTA

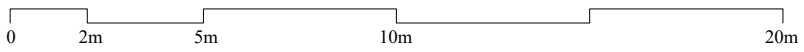

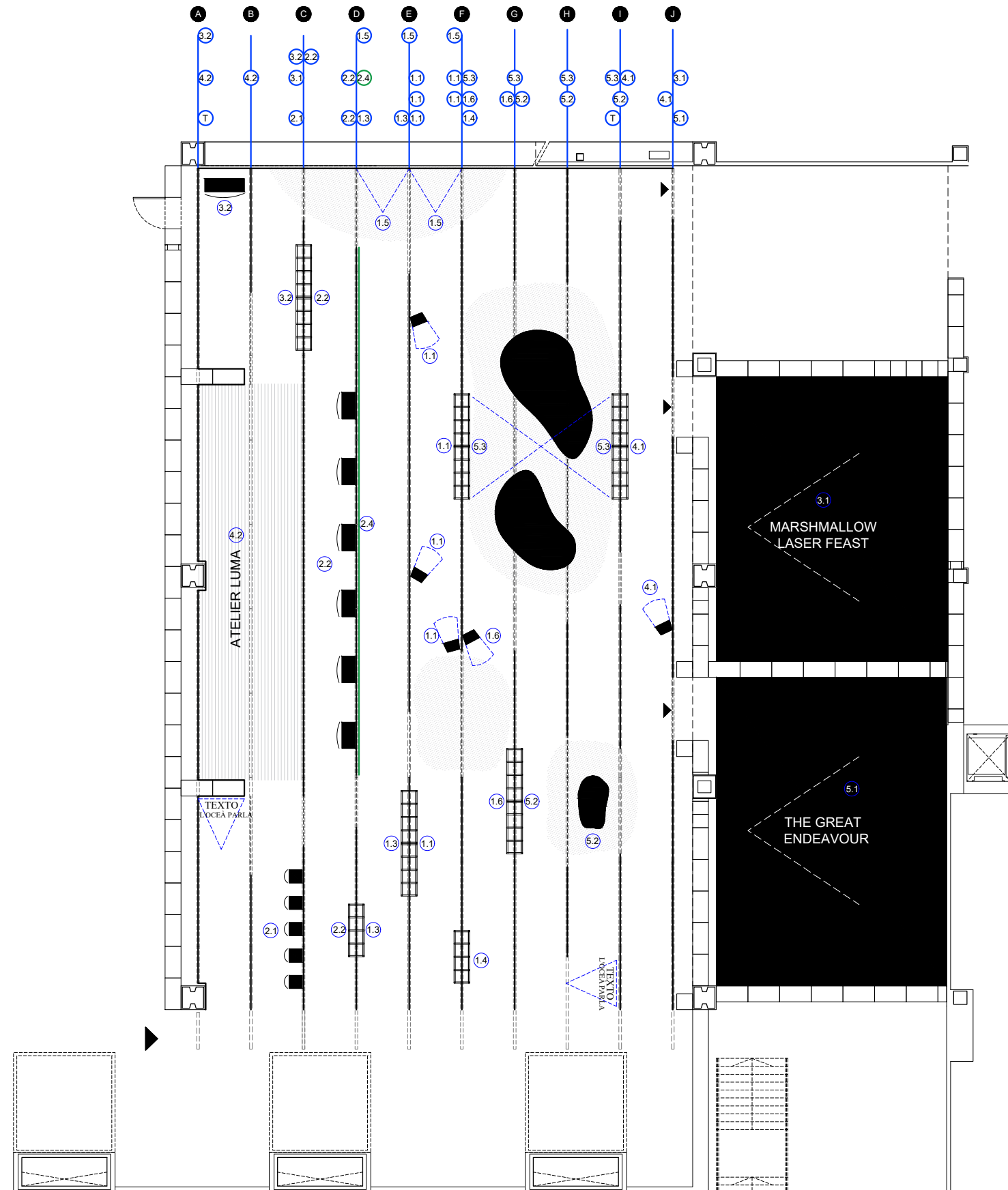

PLANTA CONTENIDO  
PLANTA

0 2m 5m 10m 20m

CONTENIDO:

**1 CONFLICTOS ZONA DE CONTACTO**

- 1.1** Second Sea
  - Web interactiva: Tablet
  - 10 Pósters impresos: Elemento vertical
  - 12 Reproducciones de fotografías enmarcadas: Elemento vertical
  - 3 Paneles Impresos: Elemento vertical
  - 2 Vídeos: 2 Pantallas + cascos
- 1.3** Escenarios futuros del frente litoral de la playa de la Pineda
  - 5 paneles impresos: Elemento vertical
- 1.4** Drift-backs in Aegean Sea
  - Web interactiva: Tablet
- 1.5** Disappearing States
  - 2 Vídeos: Instalación 2 Proyecciones
- 1.6** Embassy of the North Sea
  - Instalación: Mapa-collage con pantalla y textos incrustados
  - 2 Paneles A1 impresos
  - 5-6 Fotografías

**2 MAR, LA PRÓXIMA FRONTERA**

- 2.1** Plastiglomerados
  - 5 Muestras plastiglomerados: Peanas
- 2.2** Cartografías
  - Cartografía antigua: 15 Reproducciones de Atlas medievales
  - Elementos verticales + mesas
- 2.4** Guía de la Barcelona Submarina
  - Cortina serigráfica 2,5-3m alto, 20m largo

**3 NUEVOS PACTOS DE CONVIVENCIA**

- 3.1** Marine Bioacustics (Marshmallow Laser Feast)
  - Instalación: Caja Negra
- 3.2** Dolphin Embassy
  - 6 Dibujos impresos: Elemento vertical + mesa

**4 ECONOMÍA MARINA AZUL**

- 4.1** Pacific Aquarium
  - 9 Dibujos impresos sobre tela de algodón: Elemento vertical
  - 1 Vídeo: Pantalla
- 4.2** Atelier Luma
  - Vídeo
  - Laboratorio
  - Piezas

**5 REPARAR Y REGENERAR**

- 5.1** The Great Endeavour
  - Instalación: Caja Negra
- 5.2** Biotopo marino
  - 1 Biotopo 1x2m
  - 1 Panel explicativo: Elemento vertical
- 5.3** Urchin Corals
  - 9 Muestras de corales hechos con biopolímeros
  - 2 Vídeos: 2 Pantallas

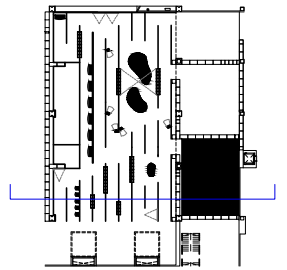
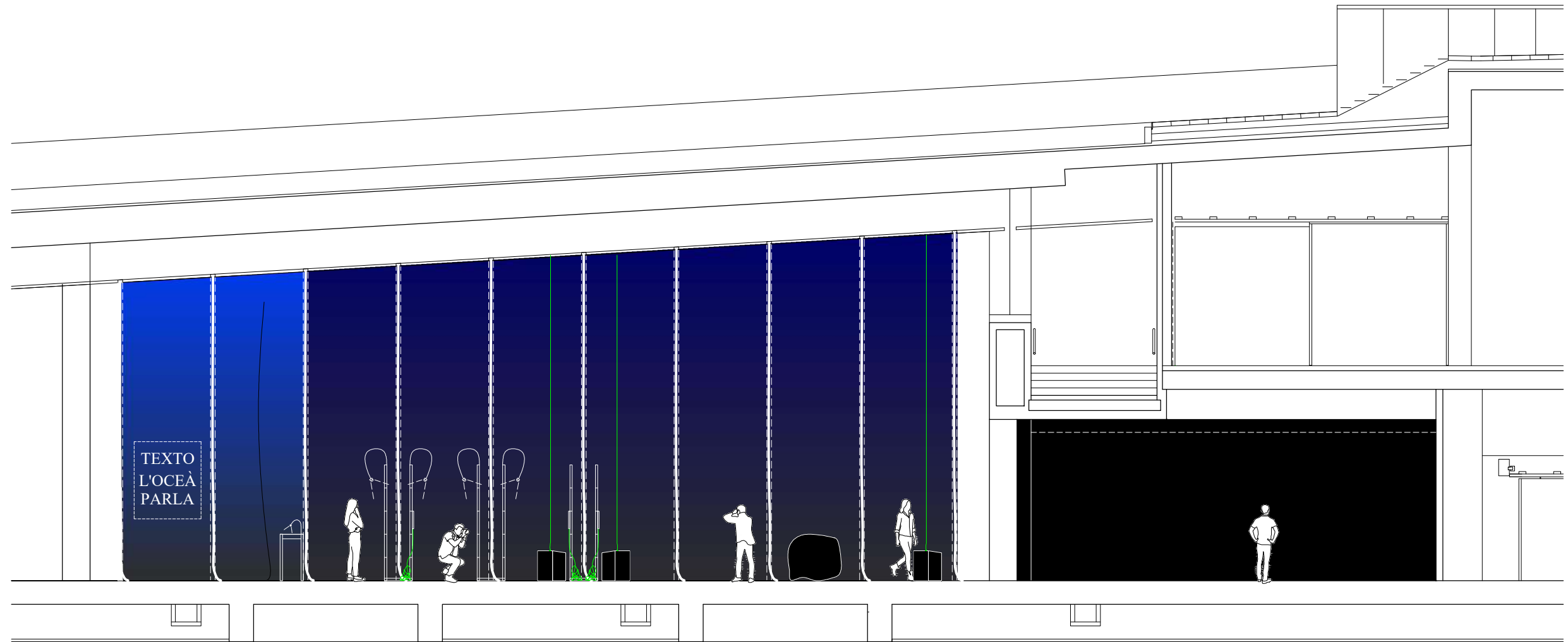

SECCIÓN



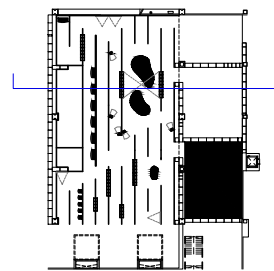
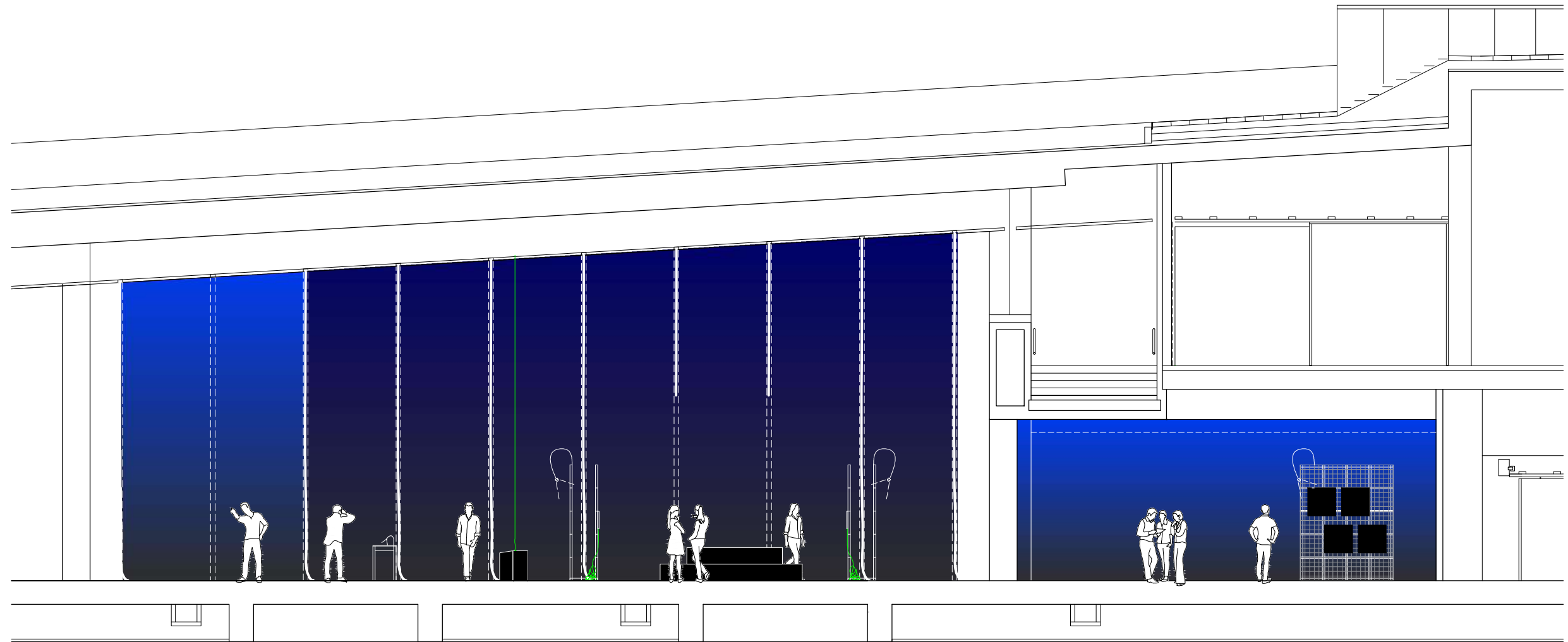

SECCIÓN





## 2. SISTEMA EXPOSITIVO

**ESTRUCTURA**  
Estructura fabricada con tubo cuadrado  
30x30x1,5mm

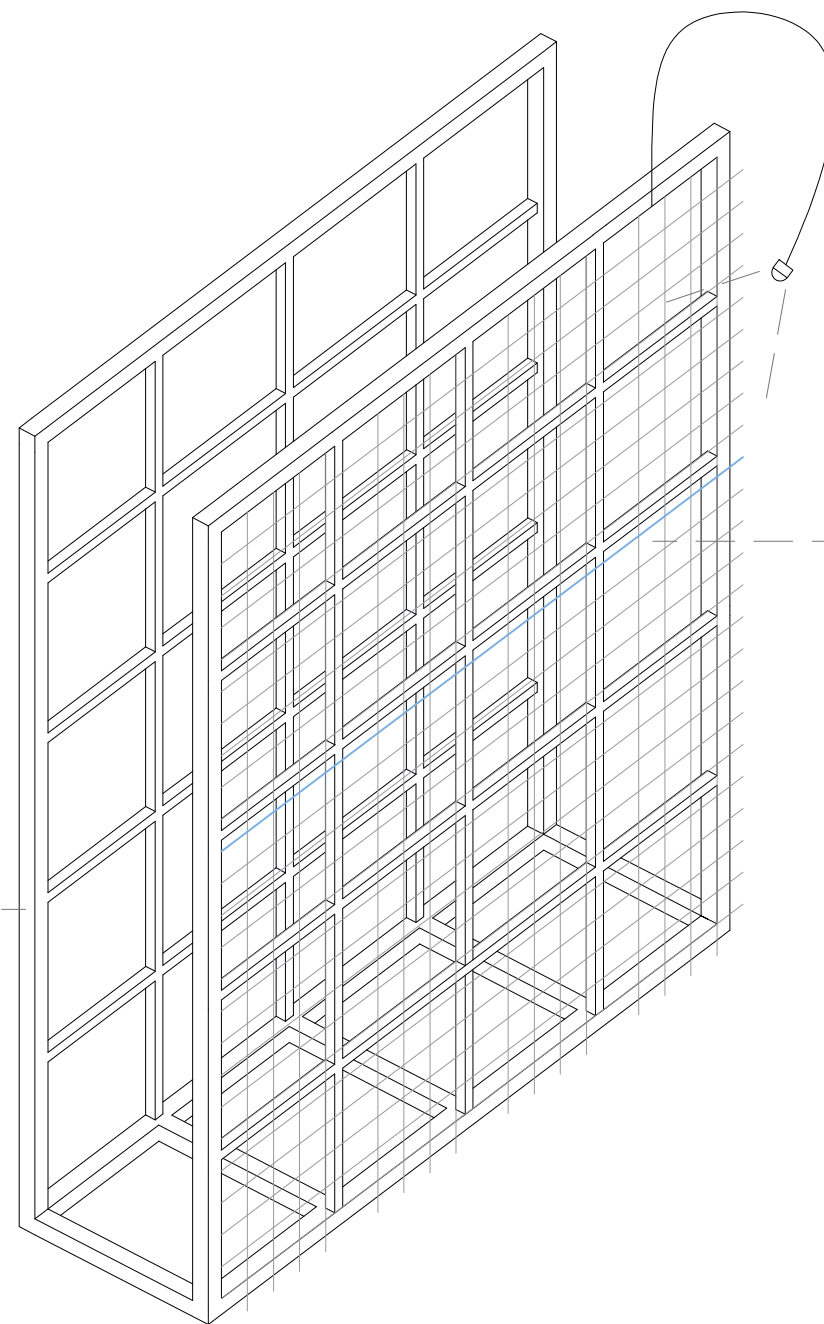

Punto de luz LED

**MALLA**  
Malla electrosoldada zincada 50x50x5

**GRAPA**

CORTINA

ESTRUCTURA

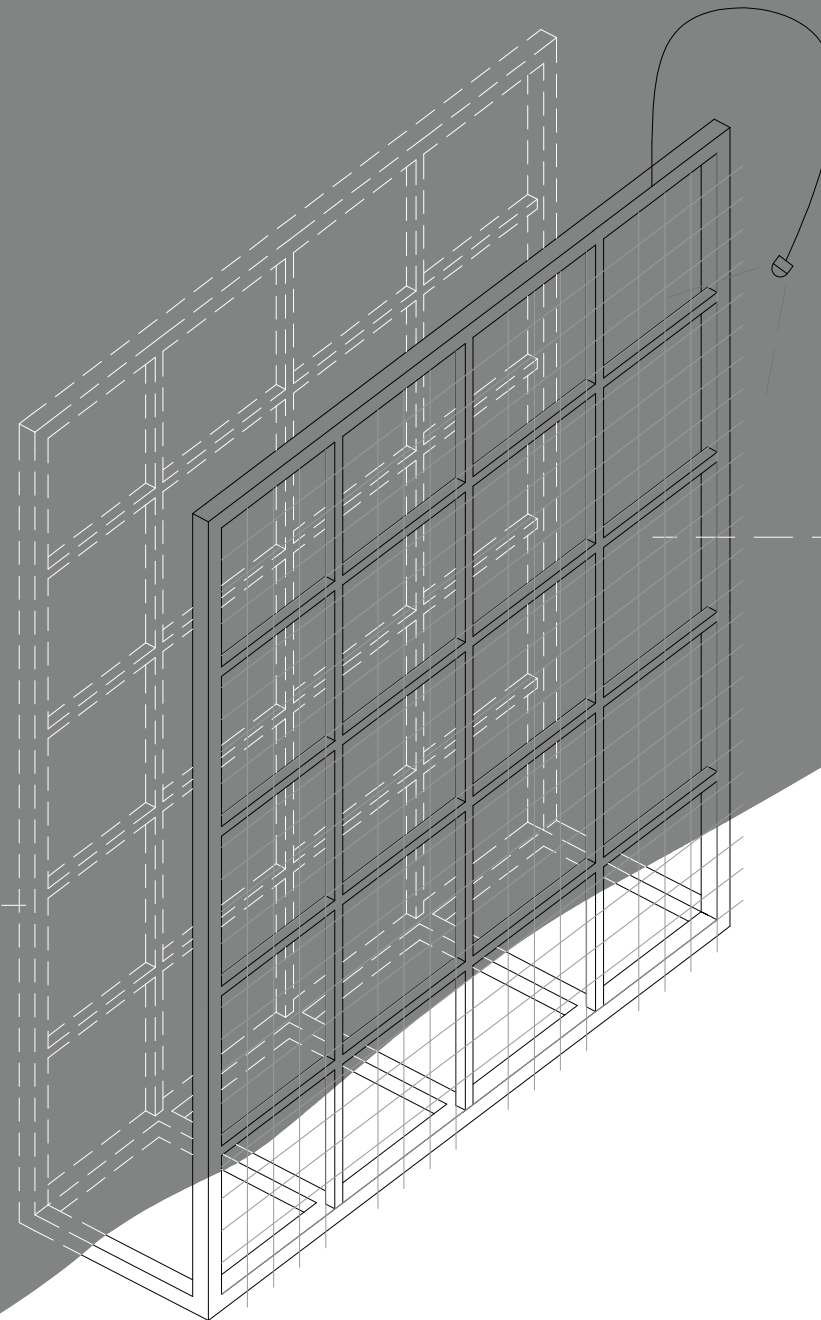

LED iluminación

MALLA

GRAPA

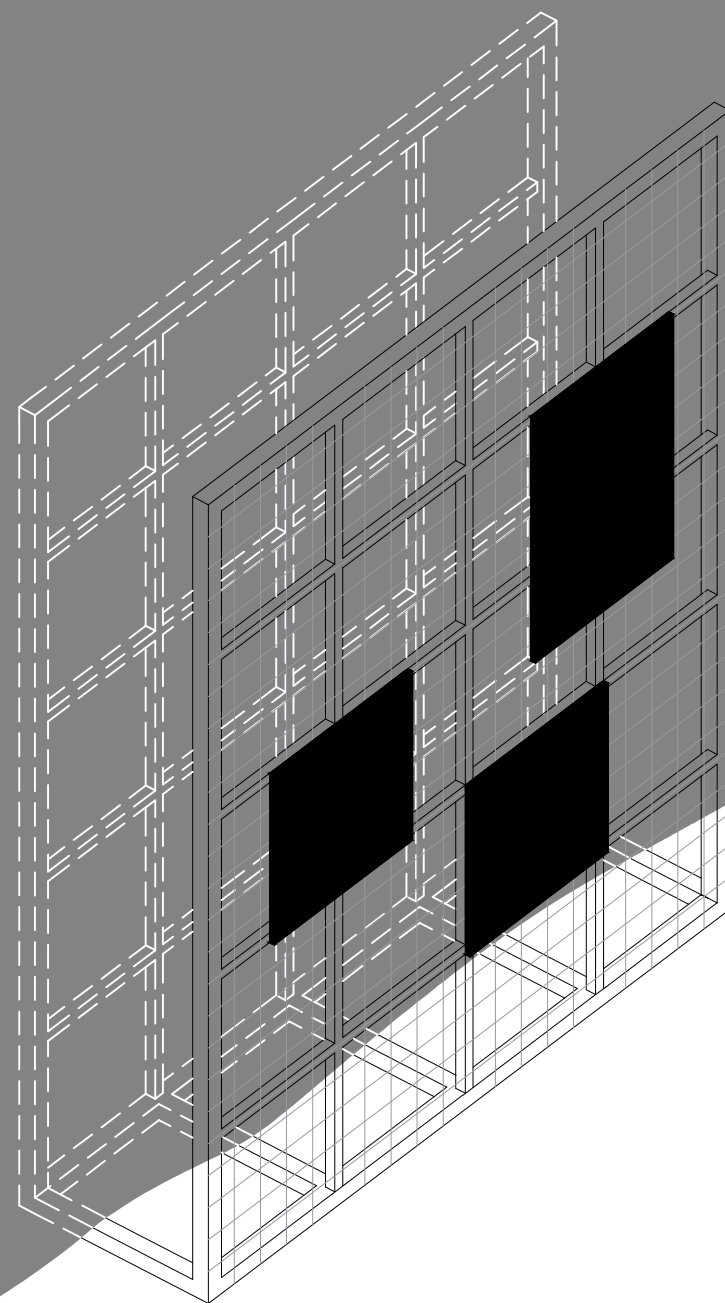

**GRAPA**  
ELEMENTOS VERTICALES

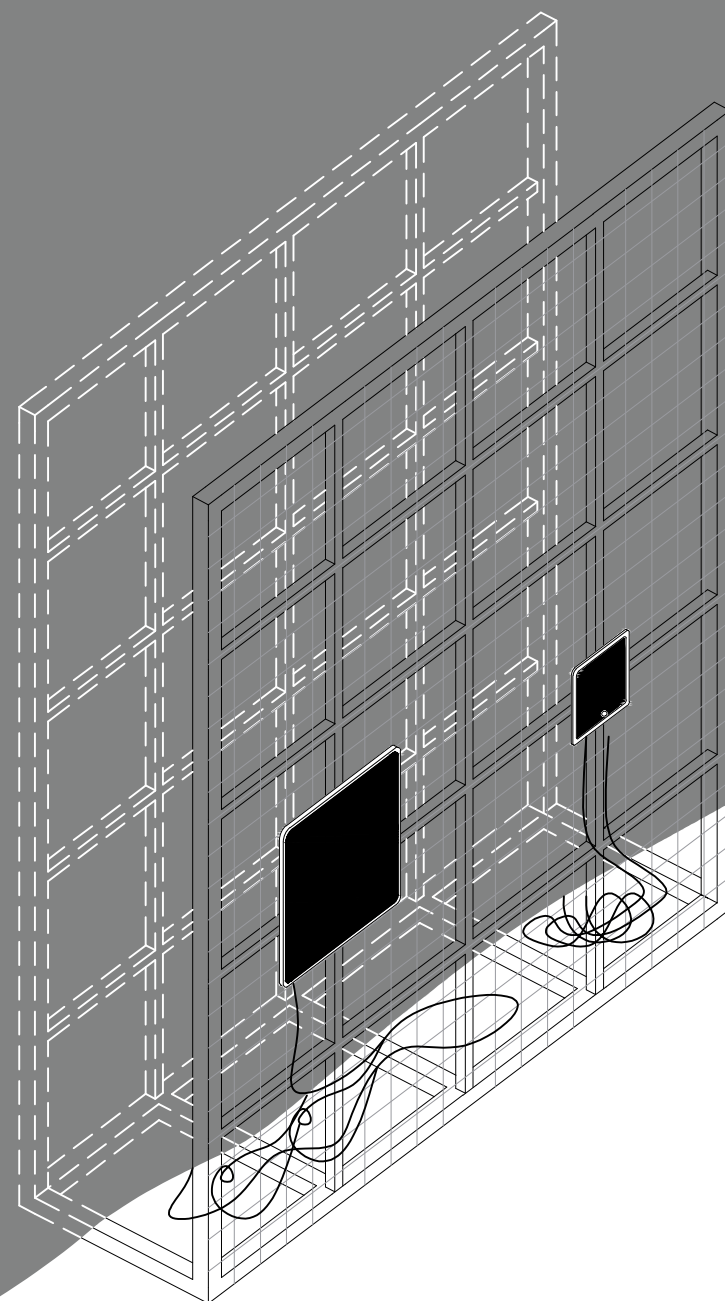

**GRAPA**  
TABLETS / PANTALLAS

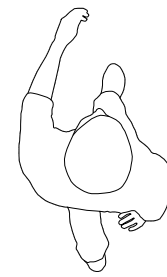
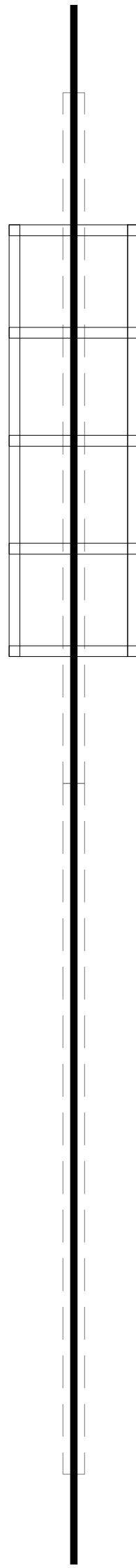
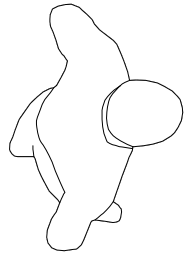
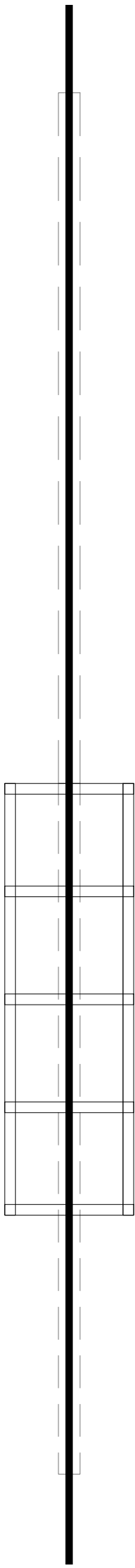

GRAPA

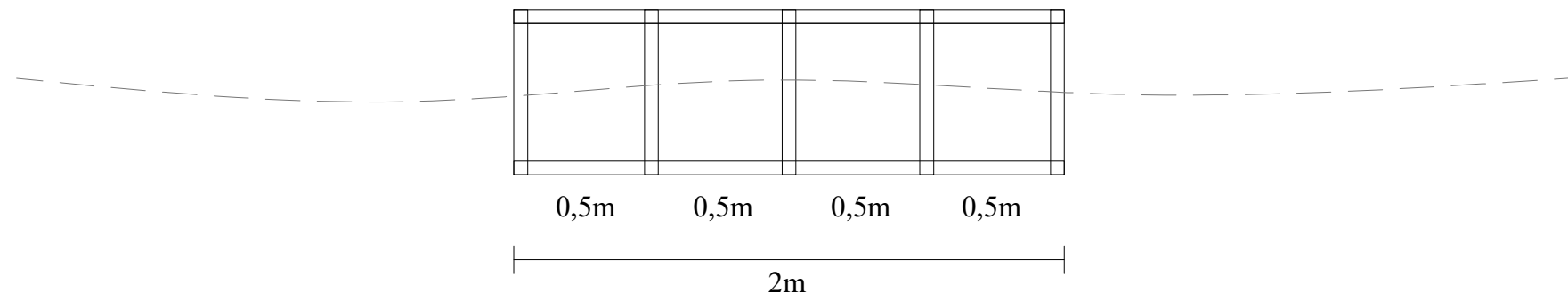
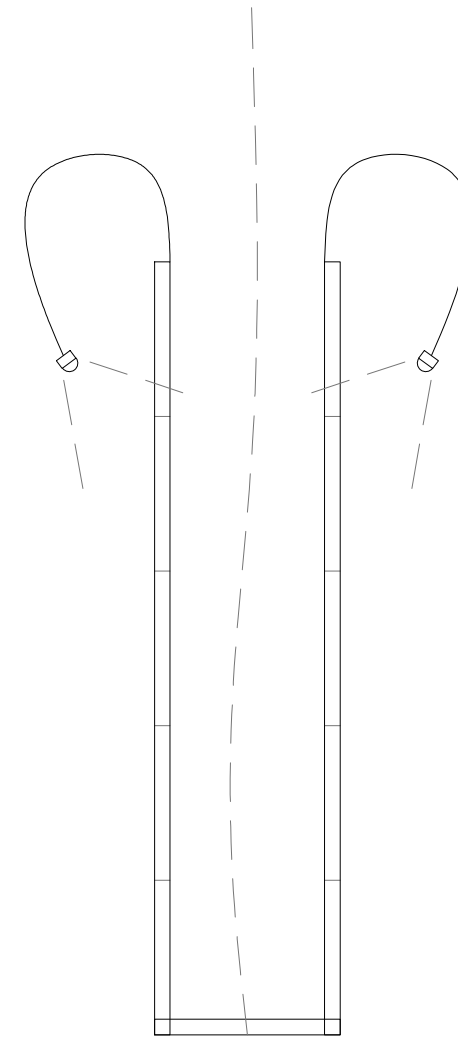
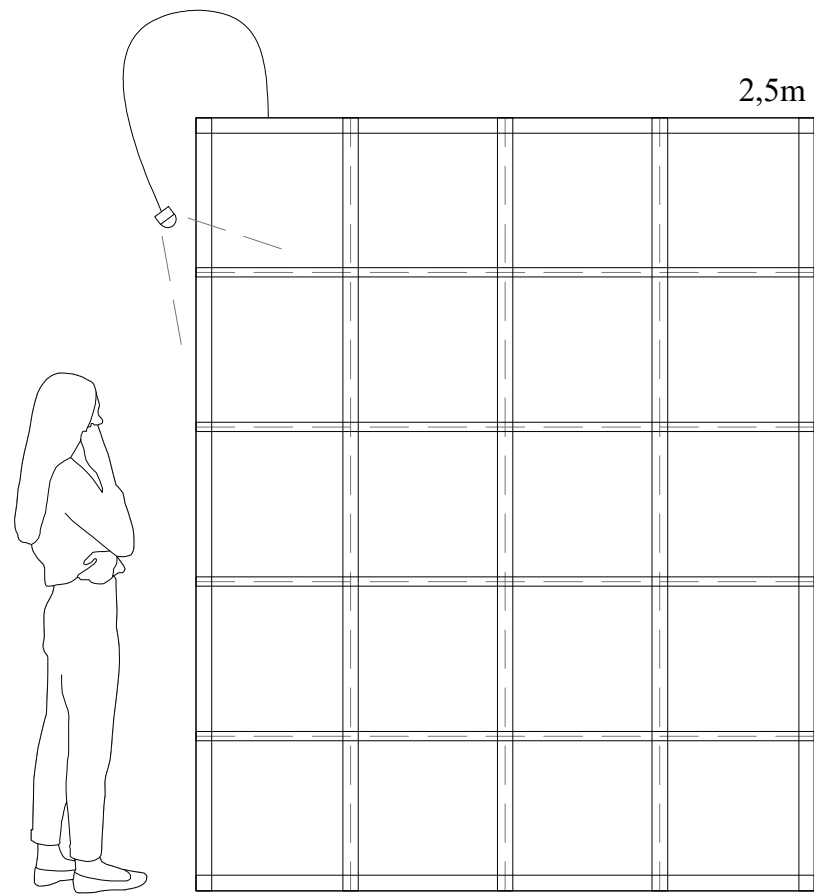

GRAPA



LANYARD



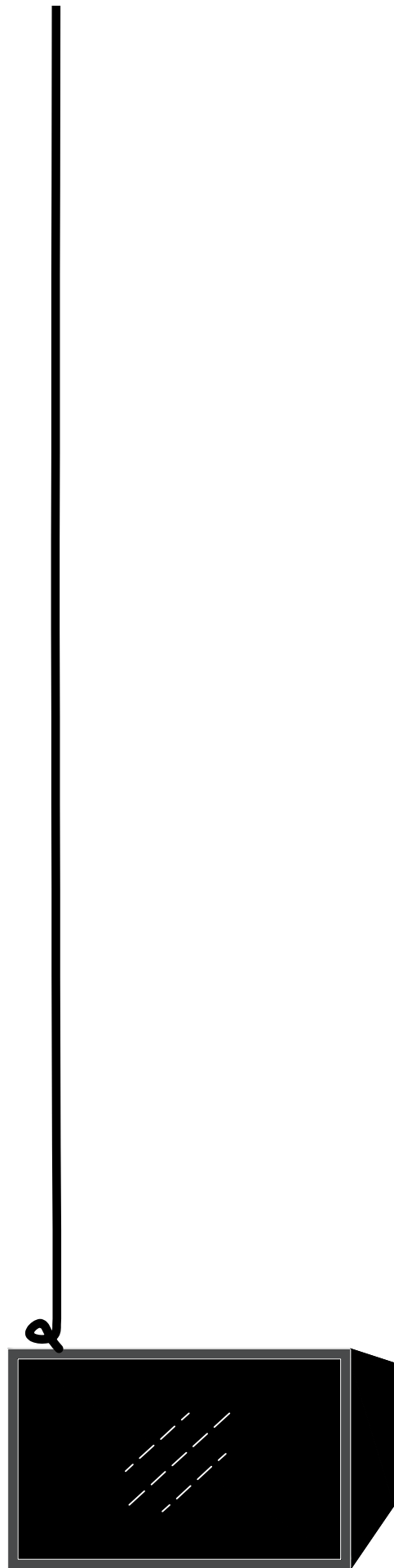

LANYARD  
PANTALLAS APOYADAS EN SUELO

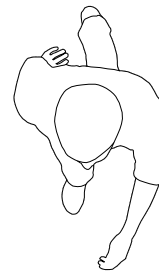
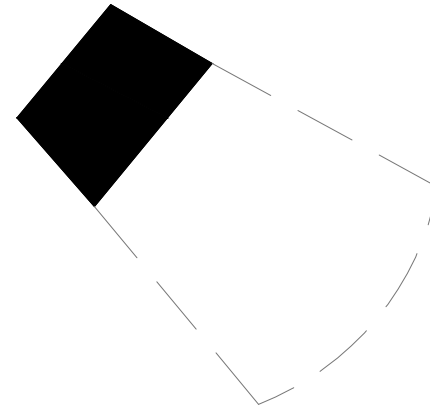

LANYARD  
PANTALLAS

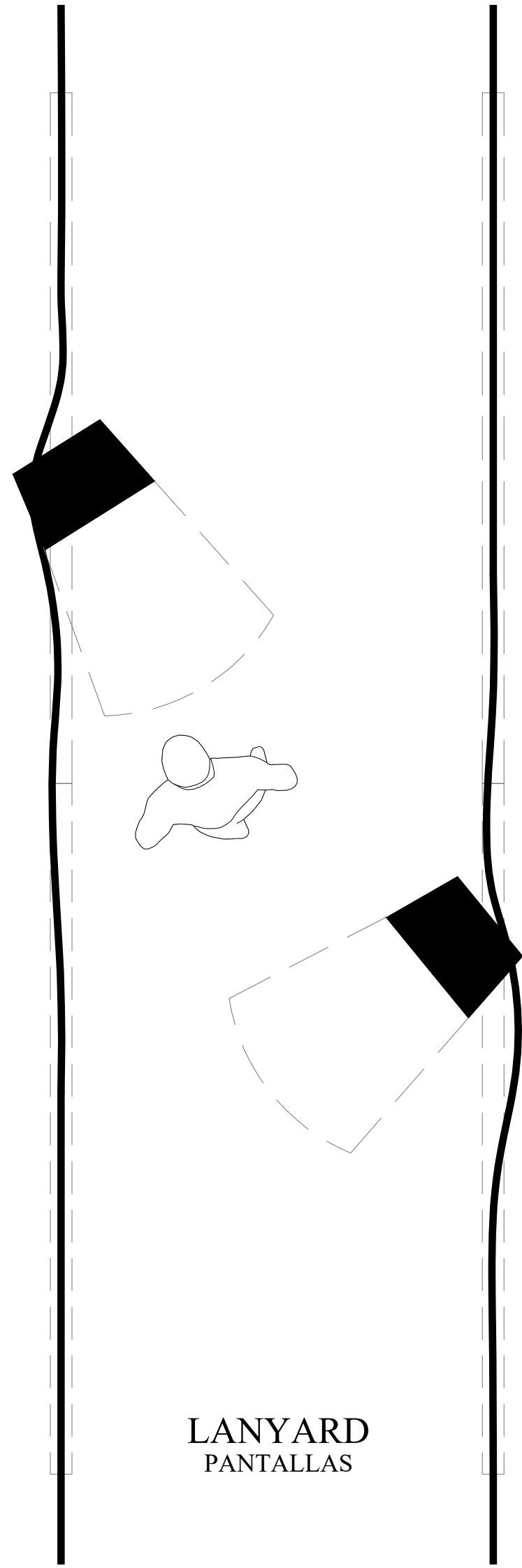
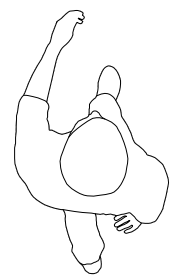

LANYARD  
PANTALLAS

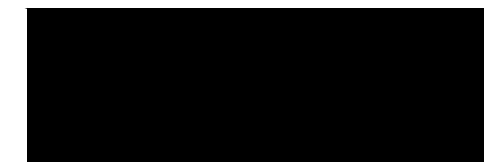
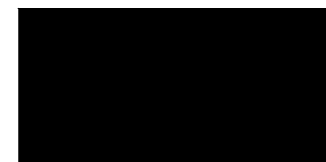
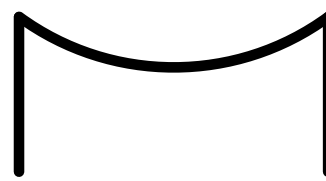
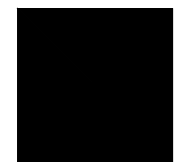
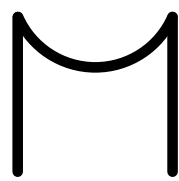

MOBILIARIO

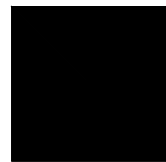
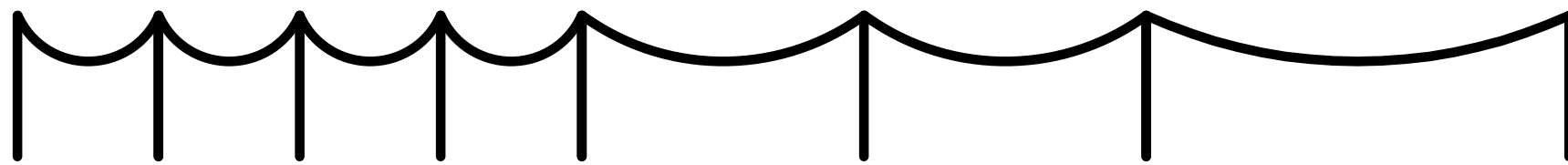

0,5m

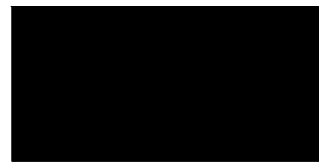

1m



1,5m

MOBILIARIO

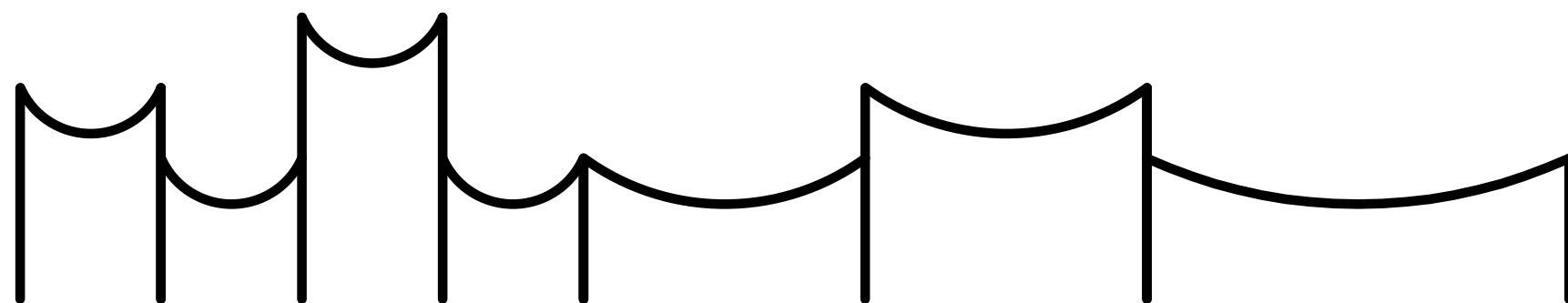

0,5m

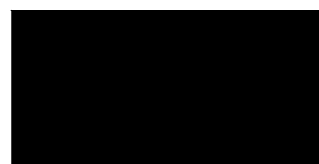

1m

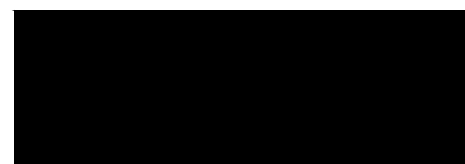

1,5m

MOBILIARIO

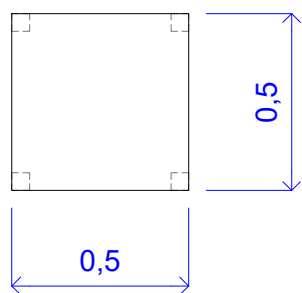
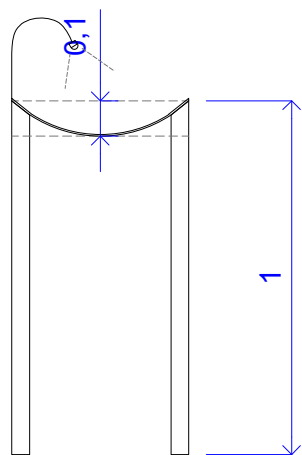

PEANA (P)

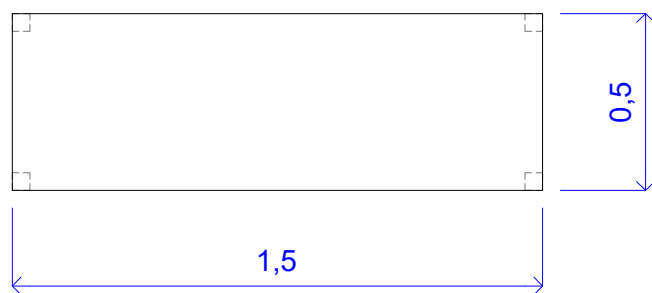
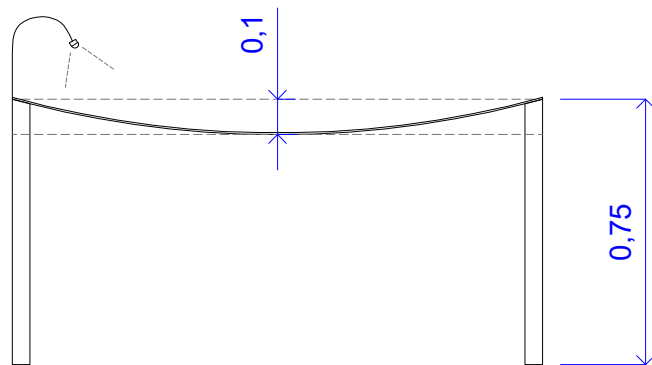

MESA (M2)

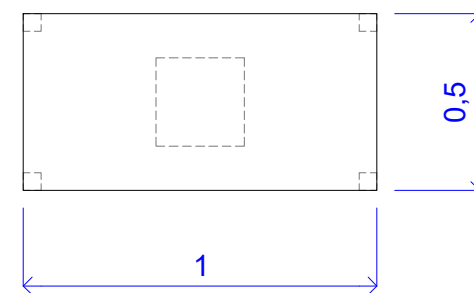
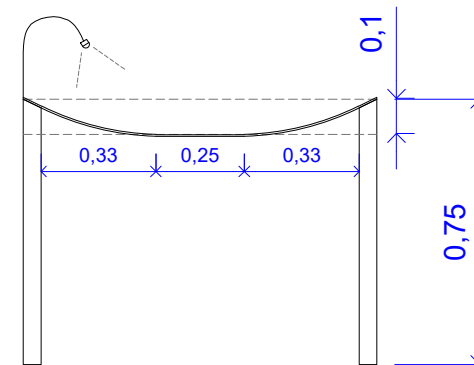

MESA (M1)

Peana y mesas fabricadas con chapa metálica de 3 mm de espesor,  
patas de 40x40x1.5mm, lacadas en RAL a decidir.

## MOBILIARIO

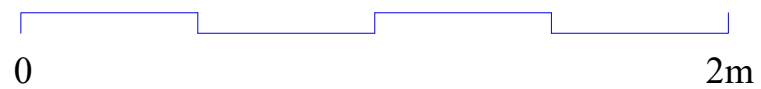

### 3. CORTINAS



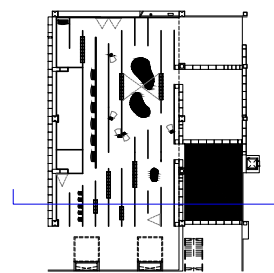
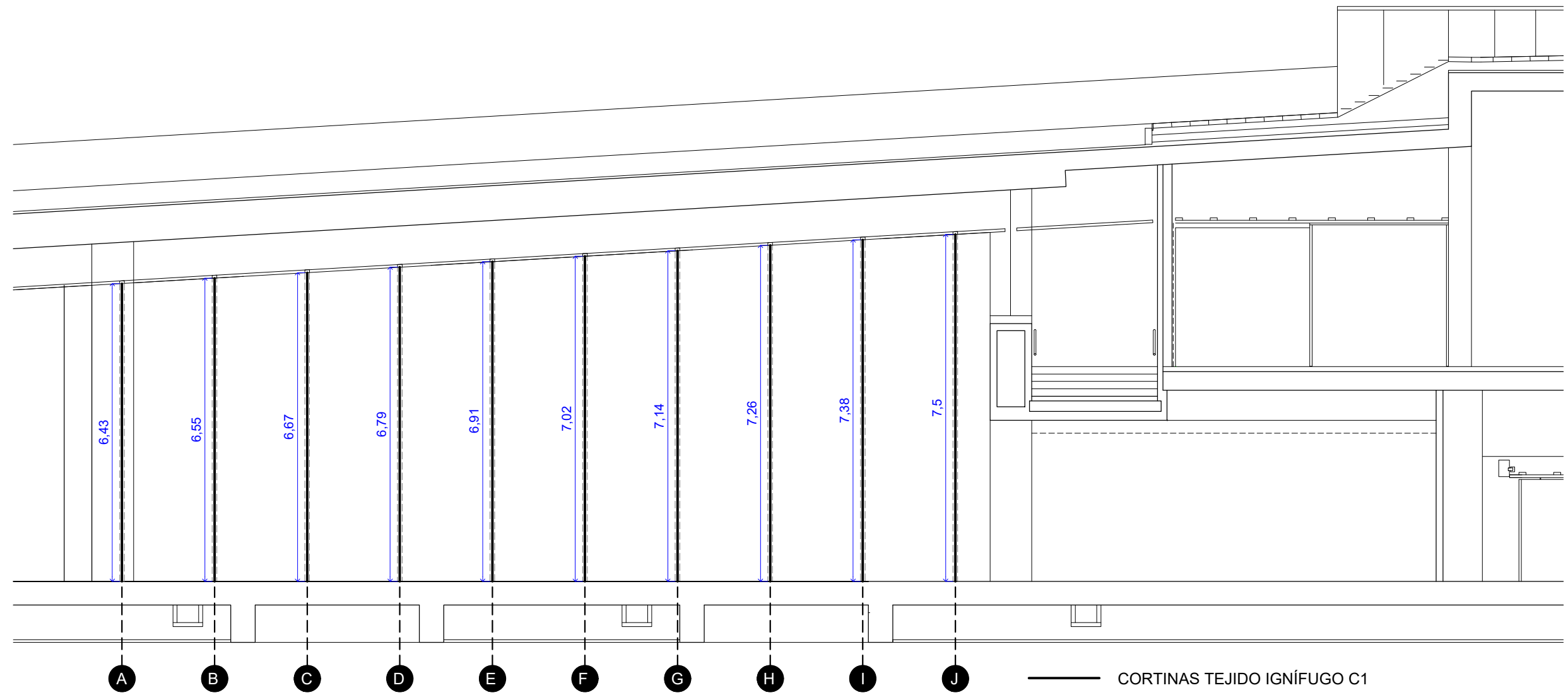

CORTINAS SECCIÓN



CORTINA A

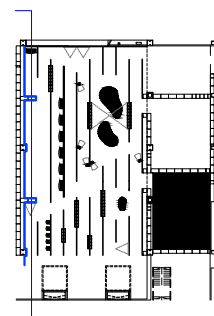
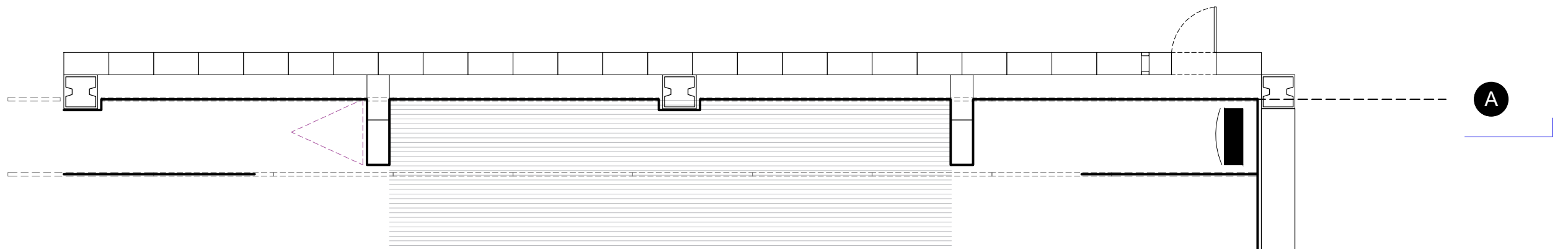
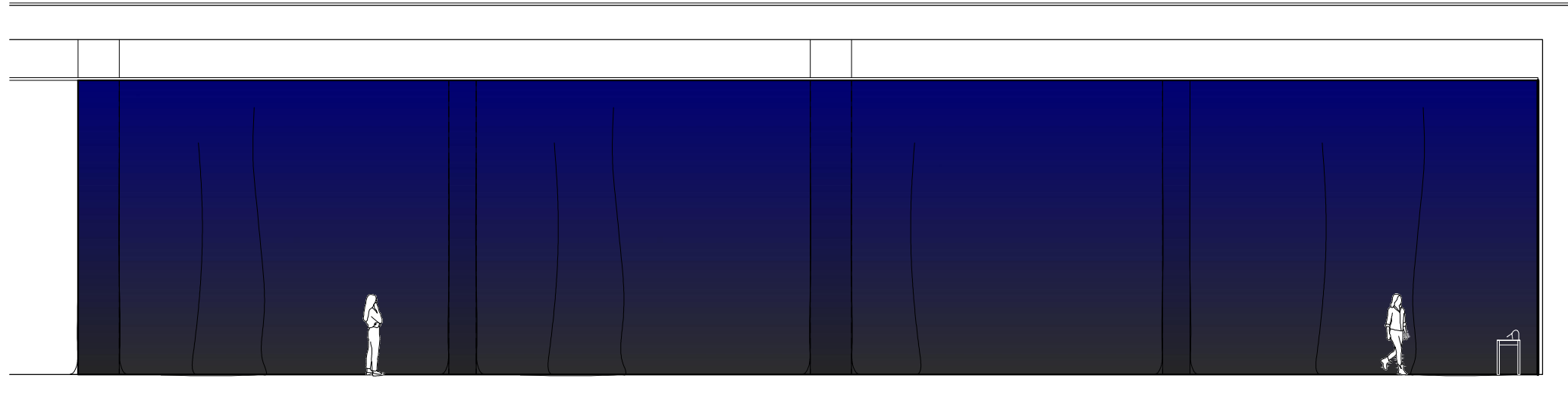

CORTINA A

0 2m 5m 10m

CORTINA **A**

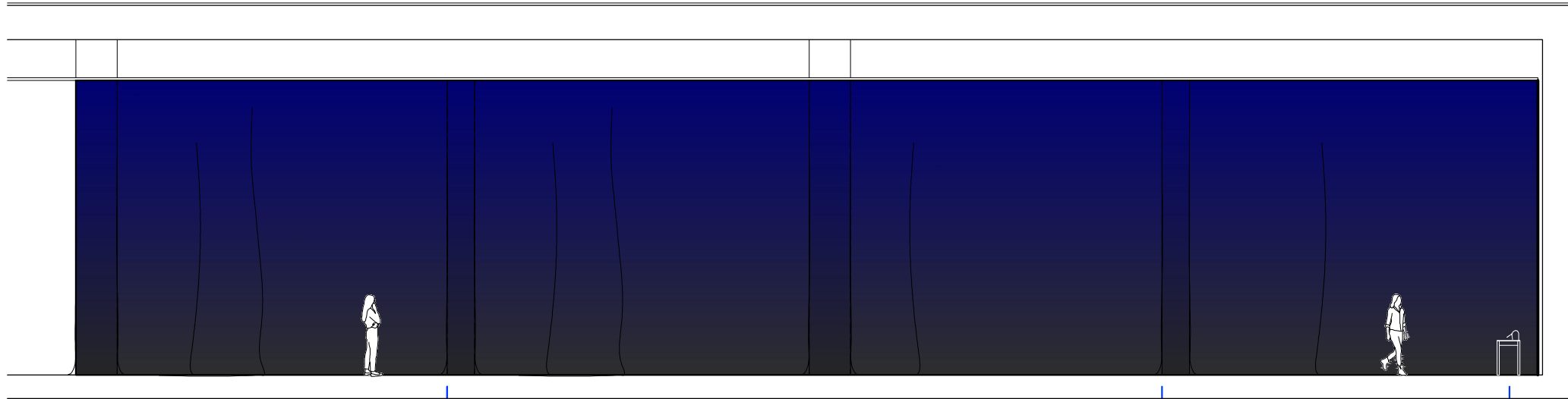

ATELIER LUMA 4.2

Mesa M1  
Dolphin Embassy 3.2  
3 Dibujos impresos 27,94x21,59cm

TEXTO T

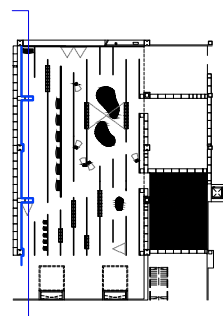
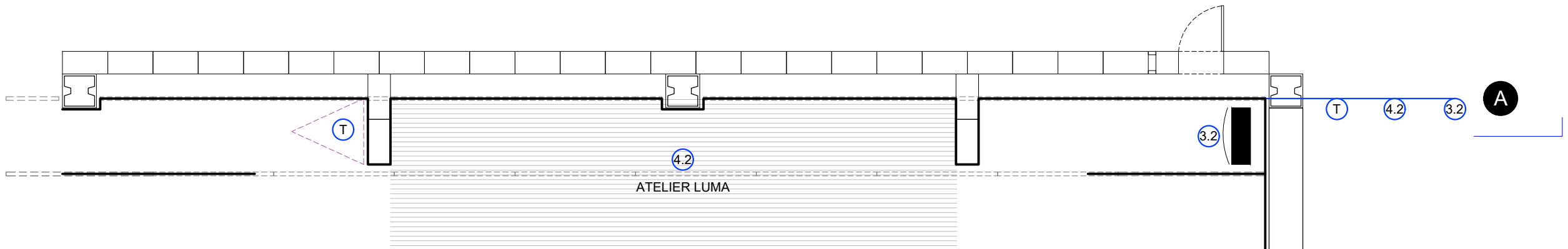

CORTINA **A**  
CONTENIDO

0 2m 5m 10m

CORTINA A 39,77m L x 6,43m H = 255,72 m2

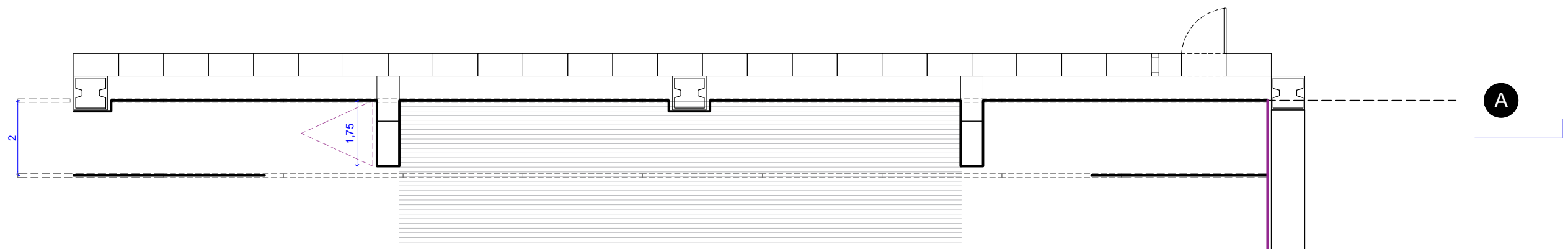
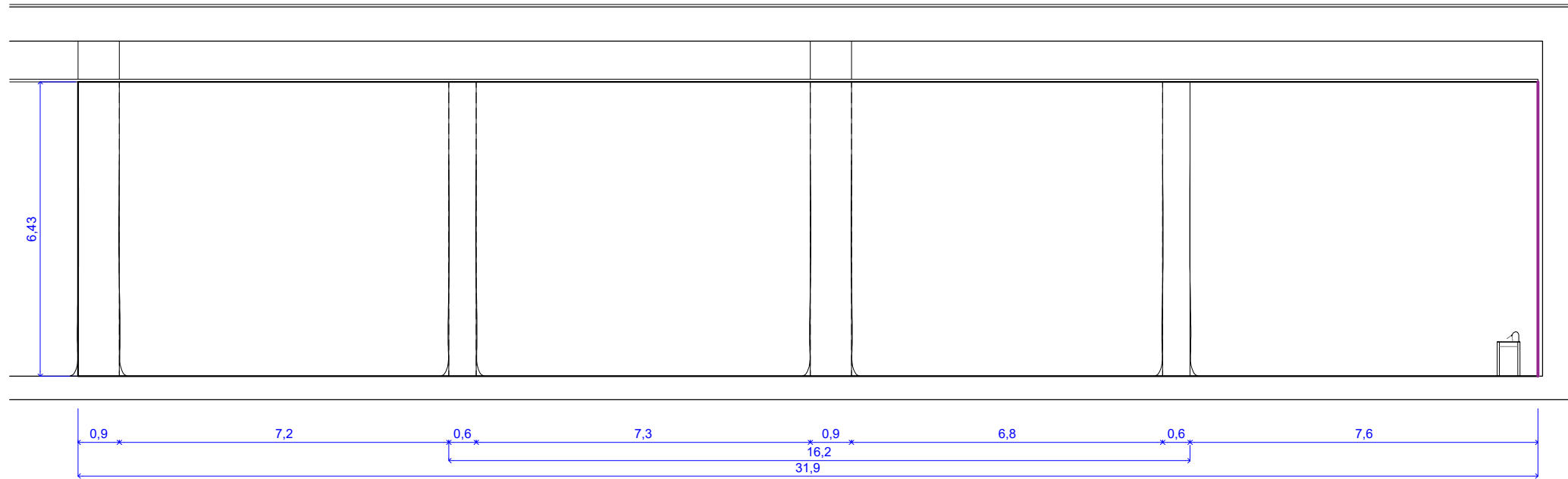

— CORTINA IGNÍFUGA C1  
— CORTINA NEGRA DHUB

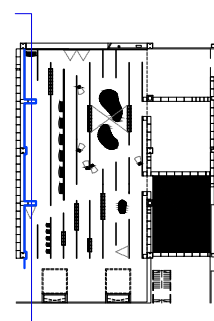

CORTINA A  
COTAS



CORTINA B

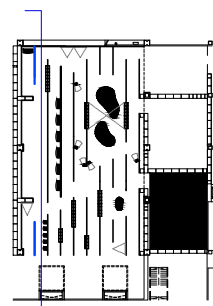
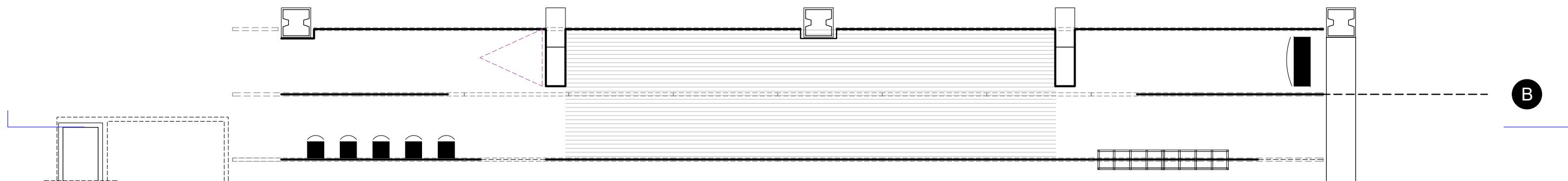
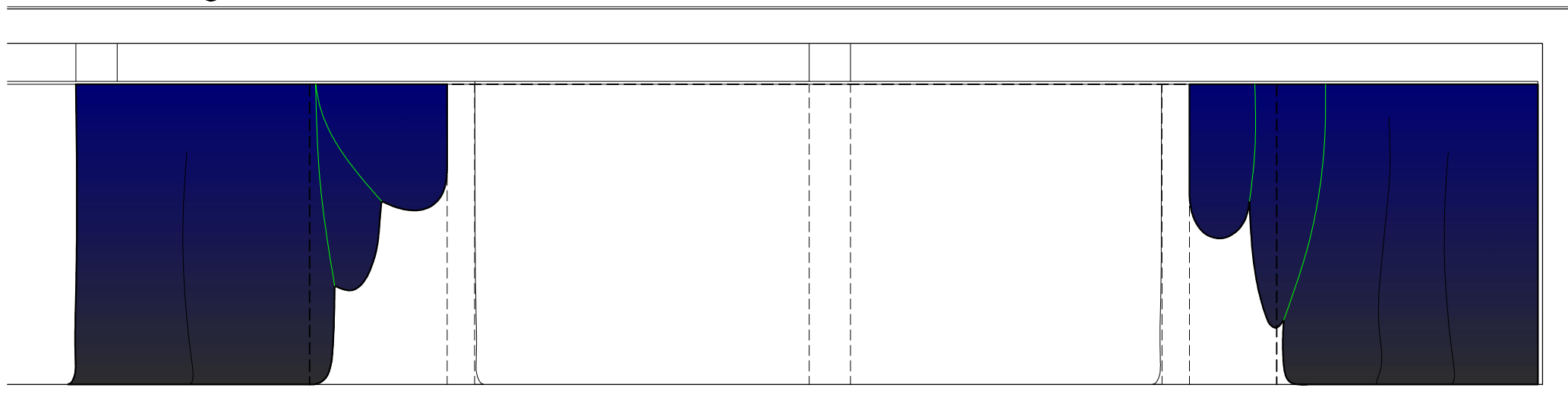

CORTINA B

0 2m 5m 10m

CORTINA B

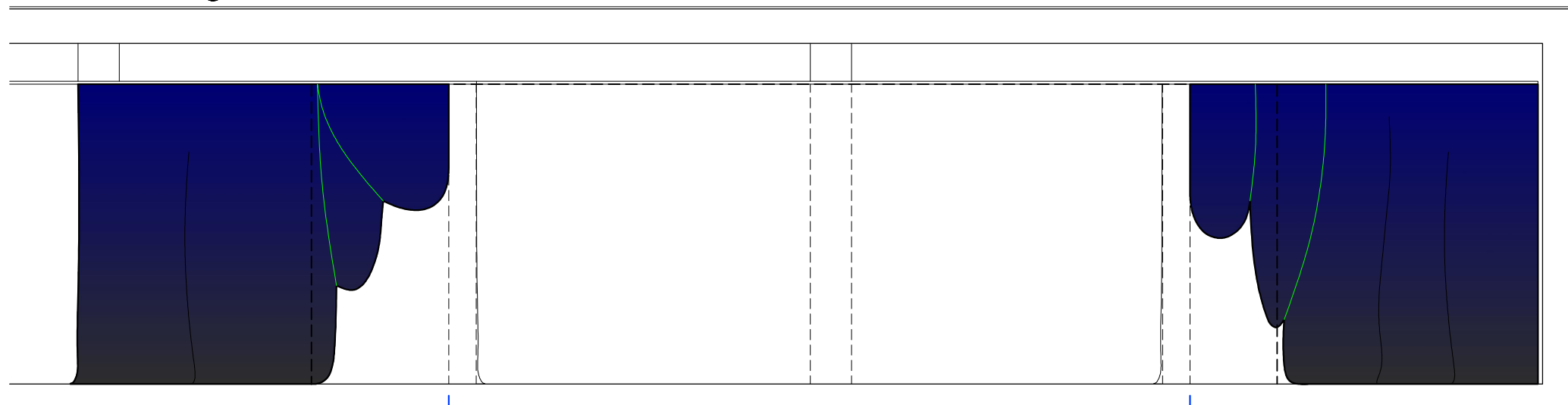

ATELIER LUMA 4.2

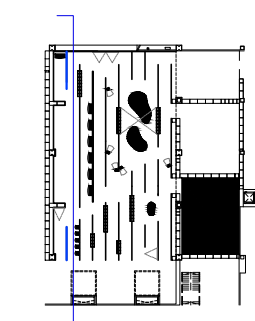
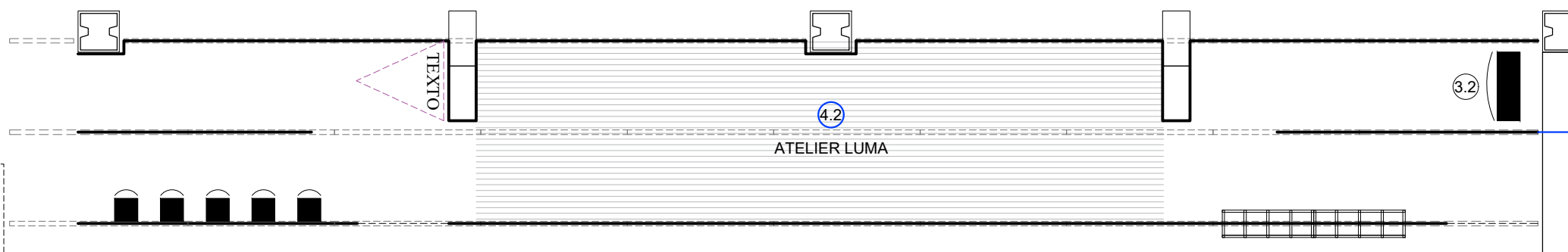

CORTINA B  
CONTENIDO CARA B1

0 2m 5m 10m

CORTINA B

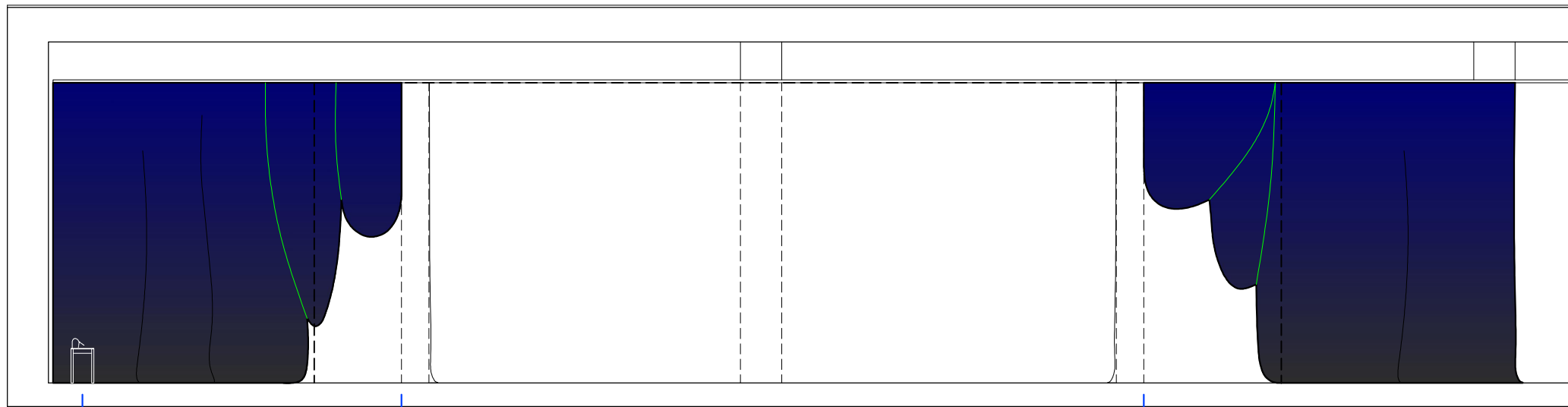

Mesa M1  
Dolphin Embassy  
3 Dibujos impresos 27,94x21,59cm

ATELIER LUMA 4.2

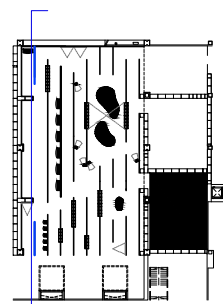
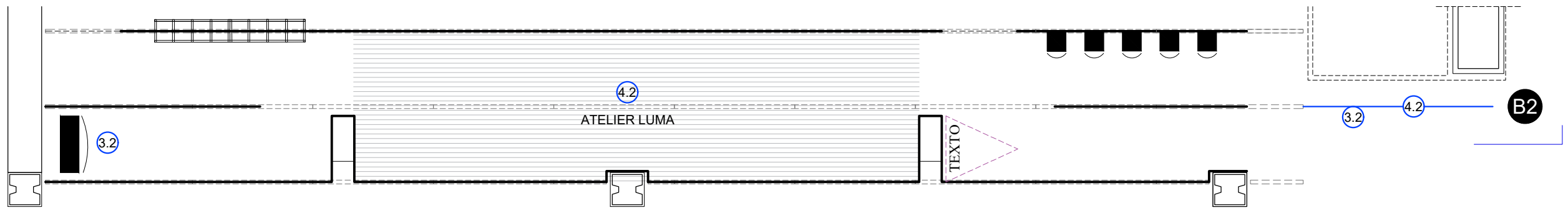

CORTINA B  
CONTENIDO CARA B2

0 2m 5m 10m

CORTINA **B** 15,7m L x 6,55m H = 102,8 m<sup>2</sup>

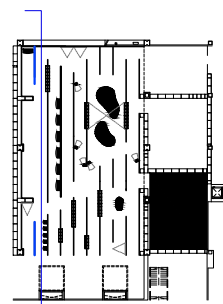
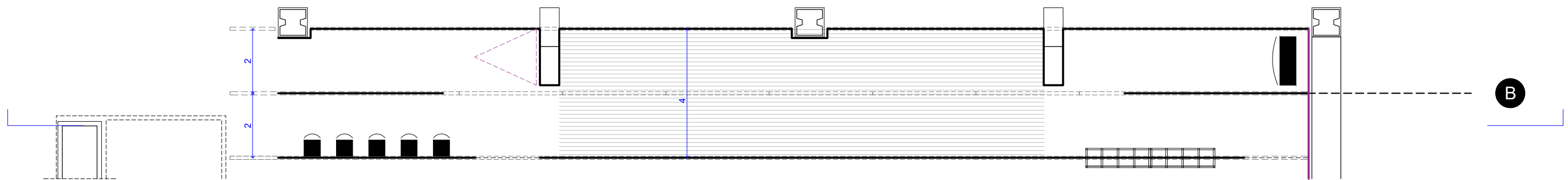
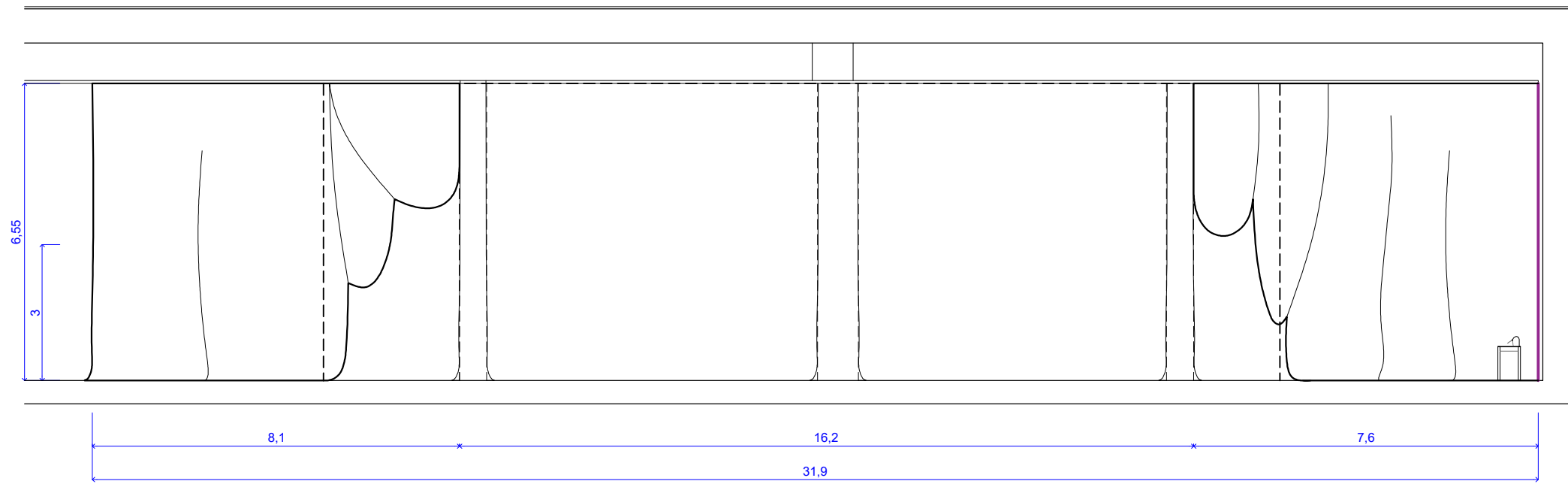

CORTINA **B**  
COTAS

0 2m 5m 10m

— CORTINA IGNÍFUGA C1  
— CORTINA NEGRA DHUB



CORTINA ③

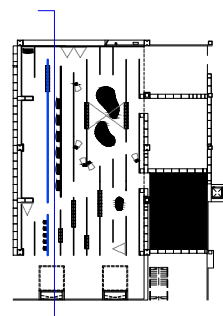
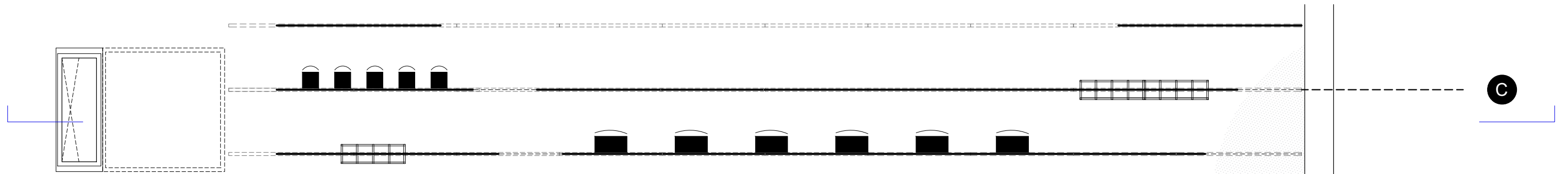

CORTINA ③



CORTINA C



2 x Grapa (G)  
2.2 Cartografías

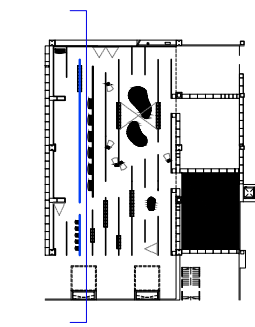
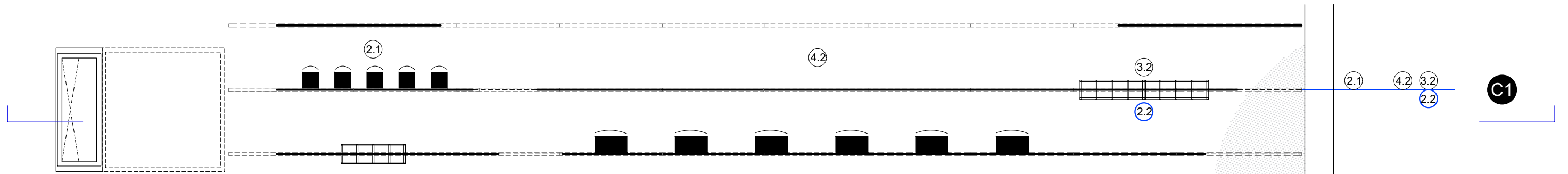

CORTINA C  
CONTENIDO CARA C1

0 2m 5m 10m

CORTINA **C**

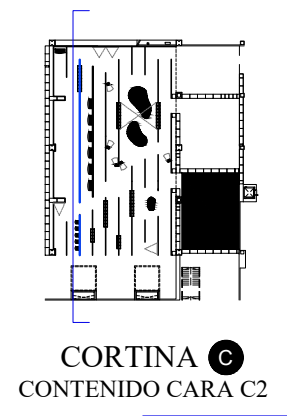
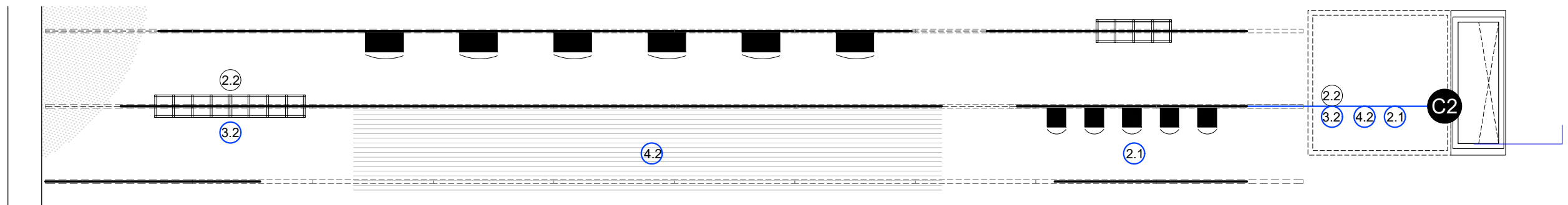
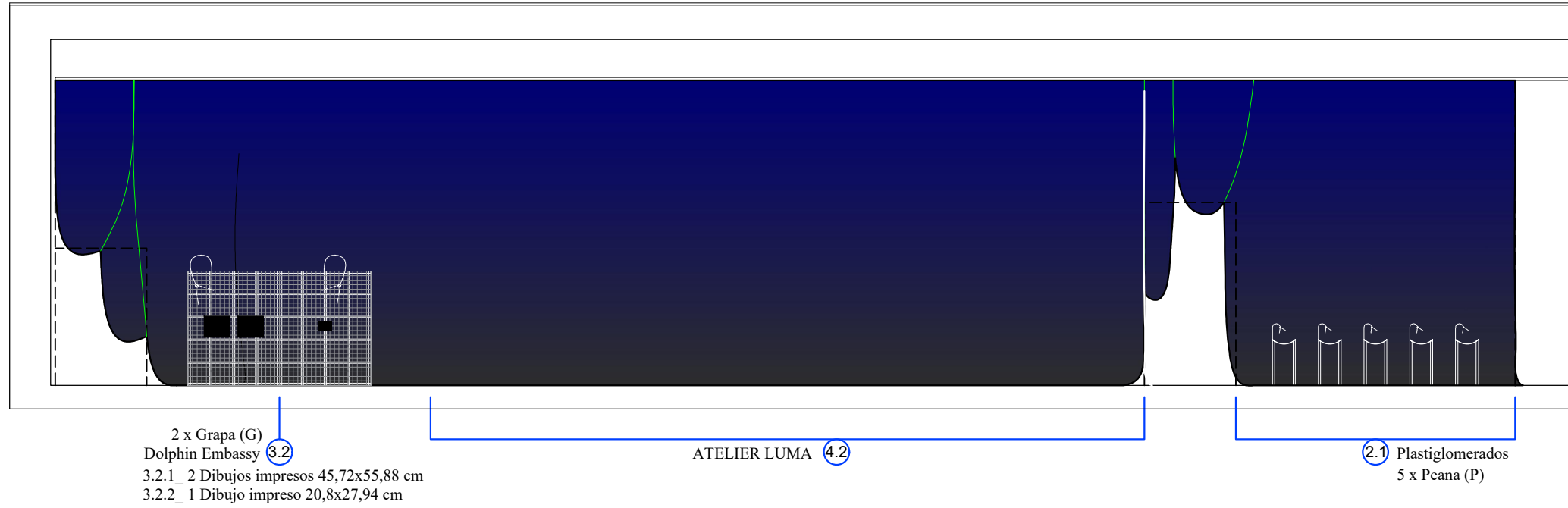

0 2m 5m 10m

CORTINA **C** 31,9m L x 6,67m H = 212,73 m<sup>2</sup>

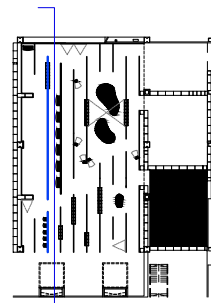
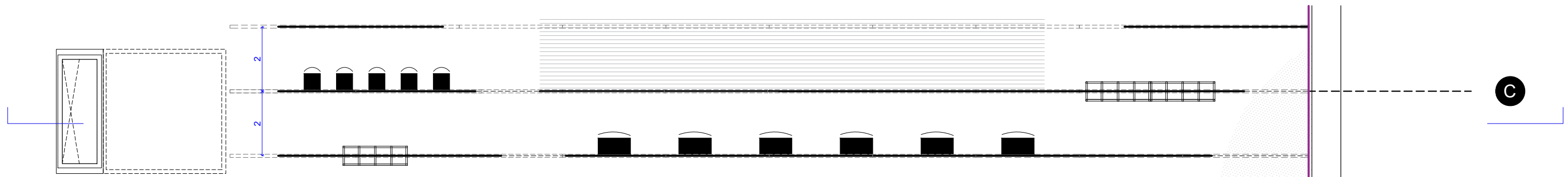
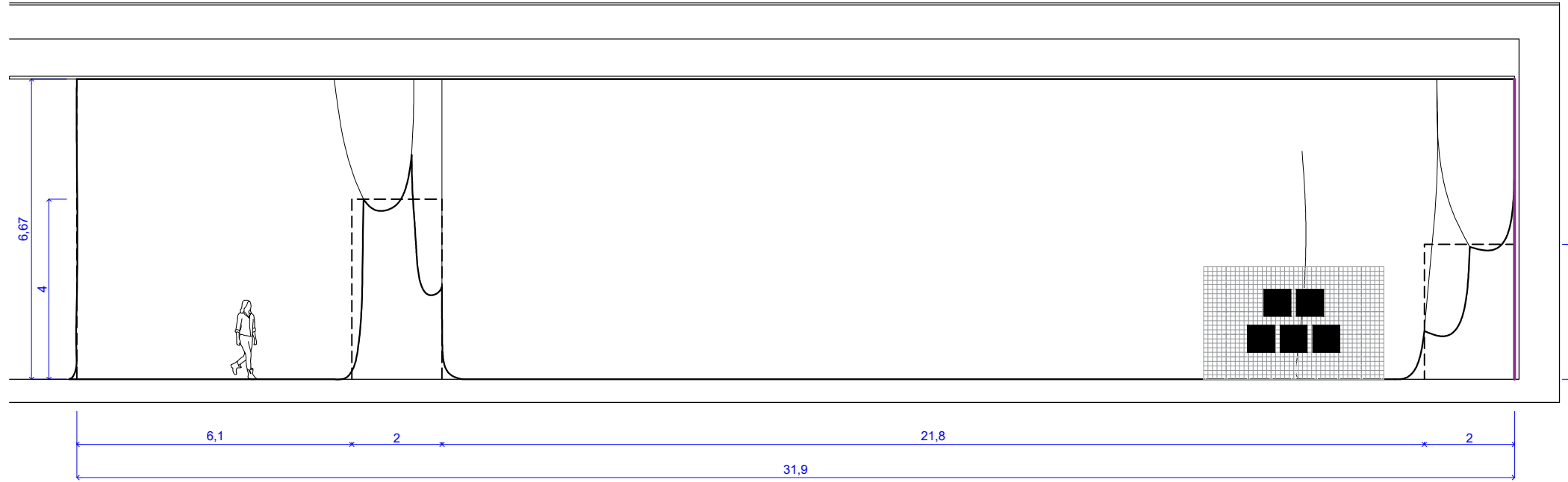

CORTINA **C**  
COTAS

0 2m 5m 10m

— CORTINA IGNÍFUGA C1  
— CORTINA NEGRA DHUB

CORTINA **D**

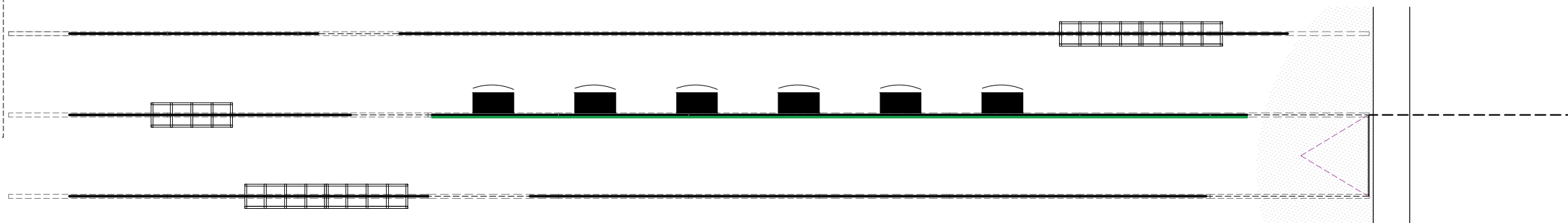
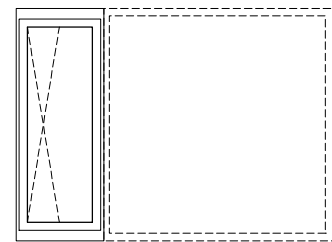
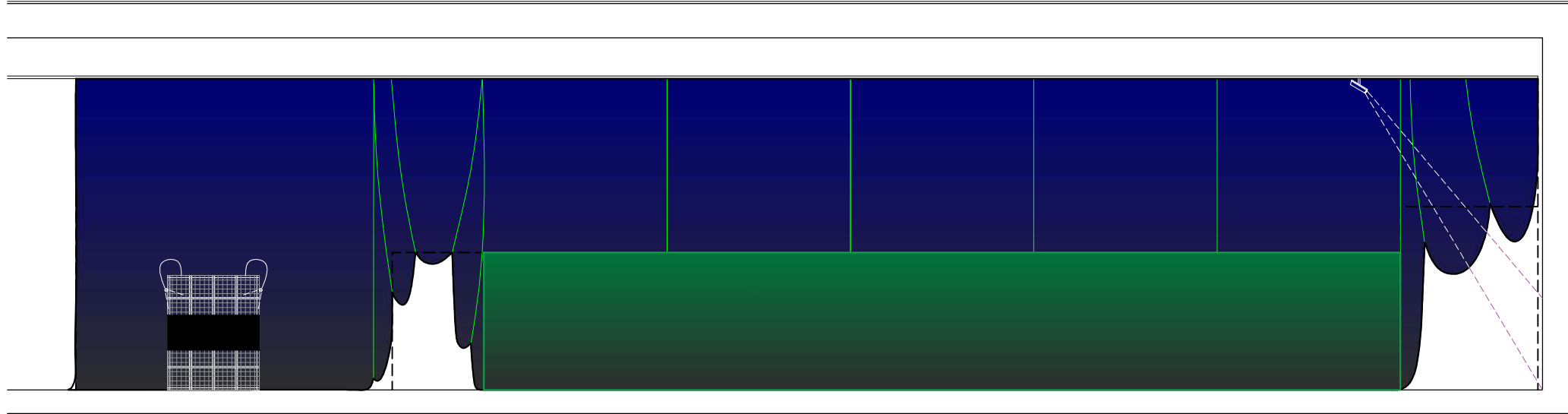

**D**

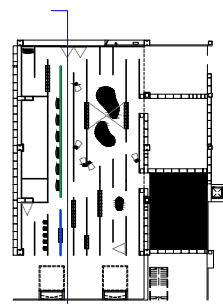

CORTINA **D**

0 2m 5m 10m

CORTINA **D**

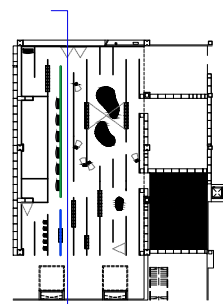
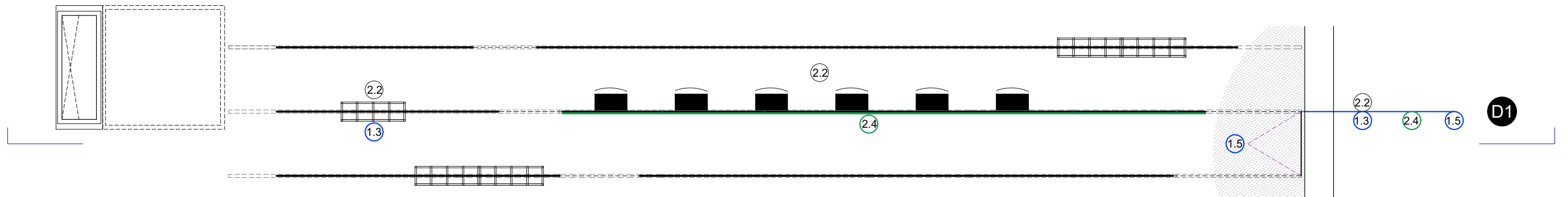
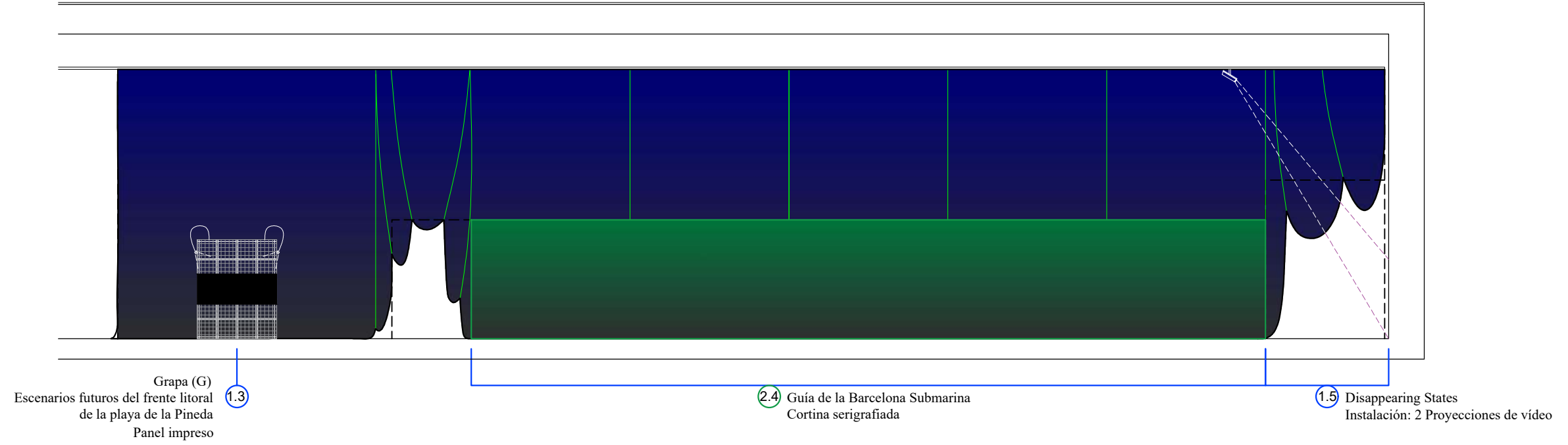

CORTINA **D**  
CONTENIDO CARA D1



CORTINA **D**

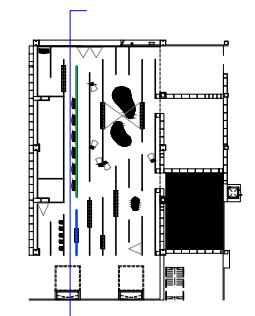
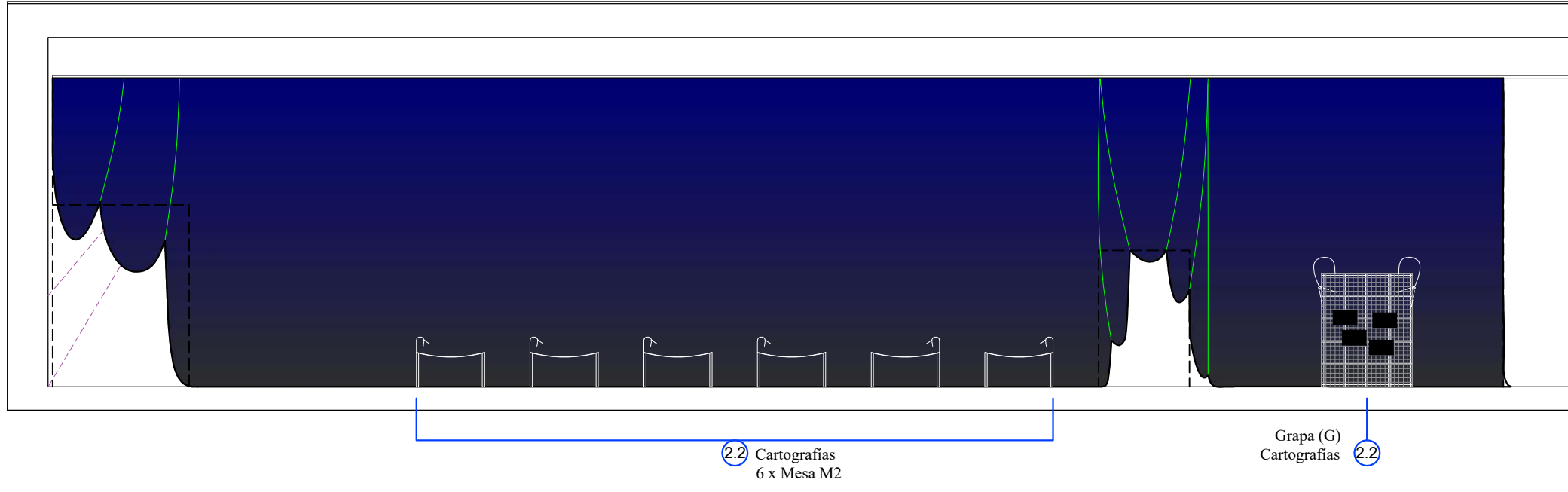

CORTINA **D**  
CONTENIDO CARA D2



CORTINA **D** 31,9m L x 6,79m H = 216,6 m<sup>2</sup>

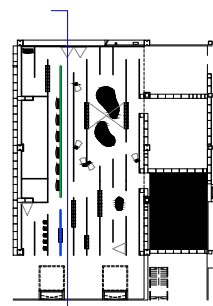
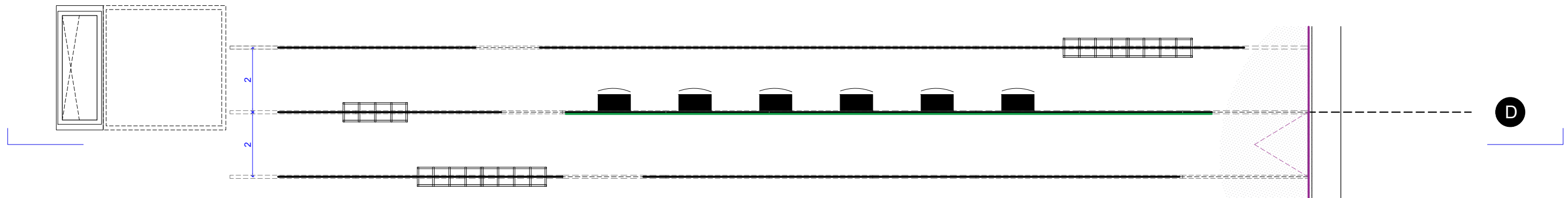
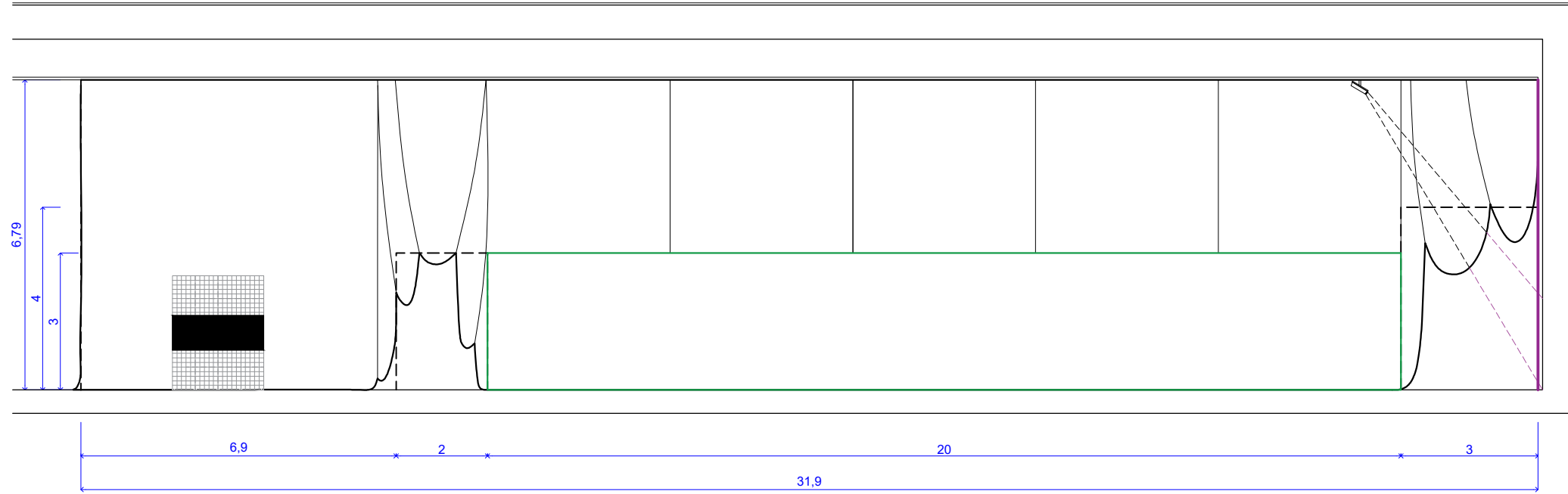

CORTINA **D**  
COTAS

0 2m 5m 10m

- CORTINA IGNÍFUGA C1
- CORTINA NEGRA DHUB
- CORTINA SERIGRAFIADA



CORTINA E

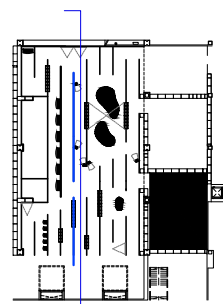
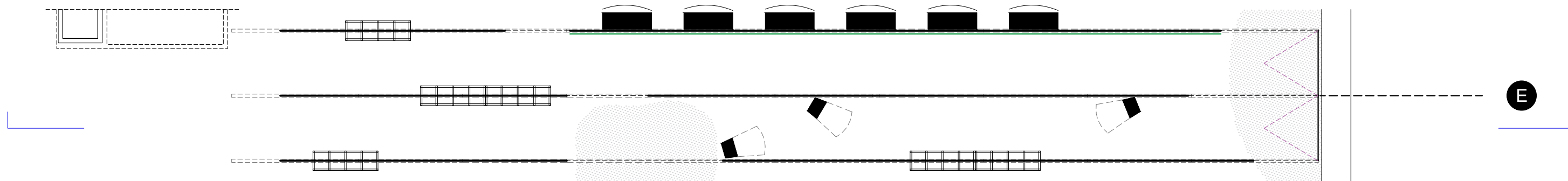
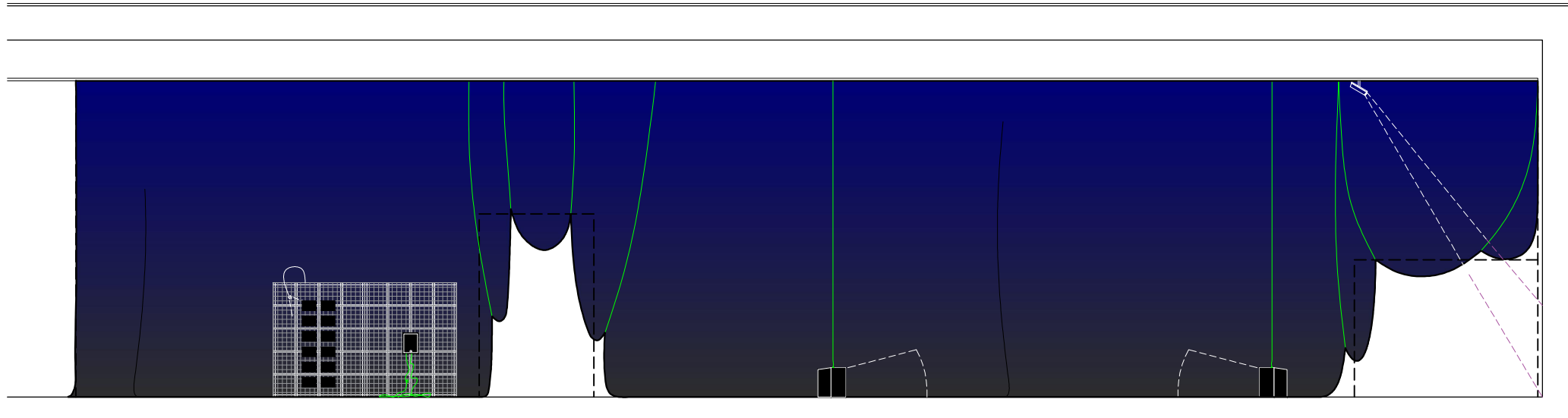

CORTINA E



CORTINA **E**

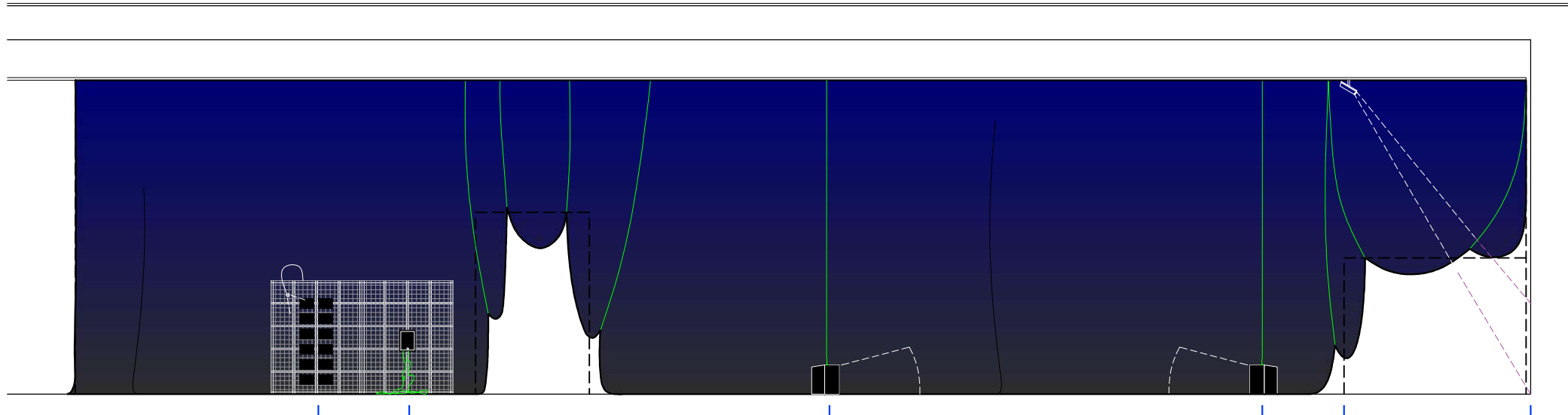

Grapa (G)  
Second Sea  
1.1.2\_12 Reproducciones de  
fotografías enmarcadas

1.1

Grapa (G)  
Second Sea  
1.1.4\_ Web interactiva: Tablet

1.1

1.1 Second Sea  
Vídeo: Pantalla + cascos

1.1

Second Sea 1.1  
Vídeo: Pantalla + cascos

1.1

Disappearing States 1.5  
Instalación: 2 Proyecciones de vídeo

1.5

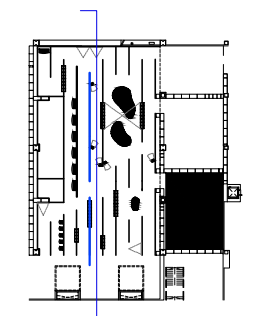
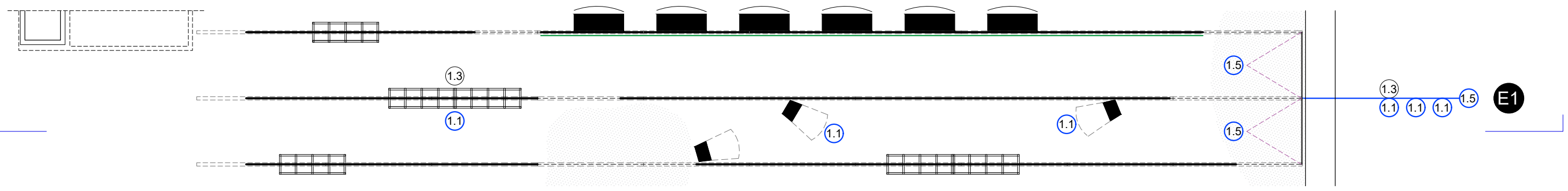

CORTINA **E**  
CONTENIDO CARA E1



CORTINA **E**

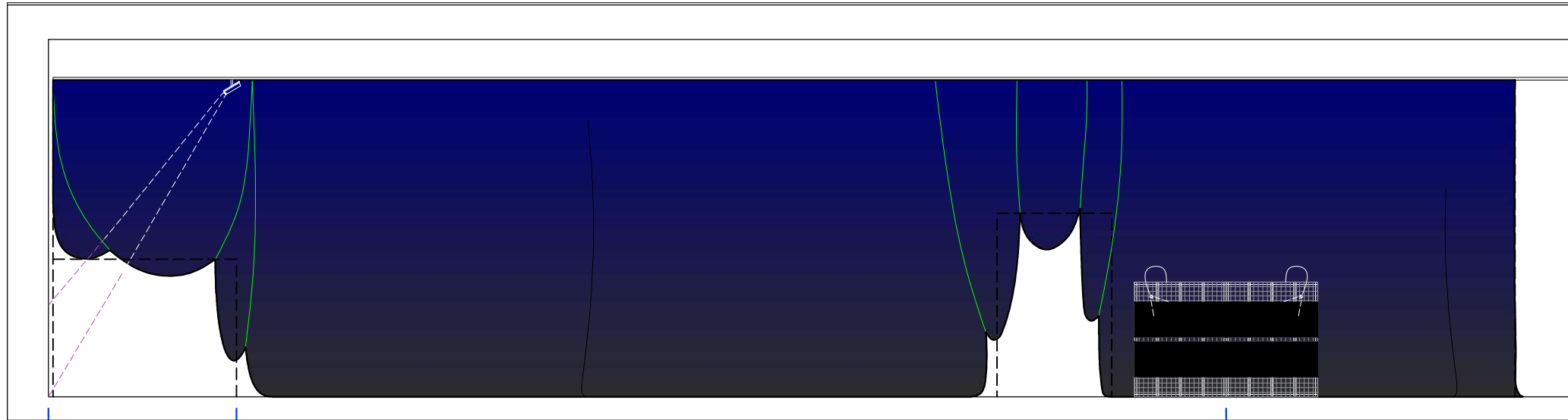

Disappearing States **1.5**  
Instalación: 2 Proyecciones de vídeo

2 x Grapa (G)  
Escenarios futuros del frente litoral  
de la playa de la Pineda  
Paneles impresos **1.3**

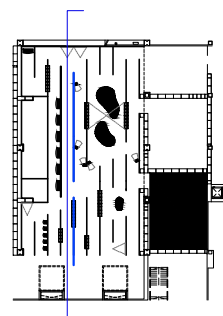
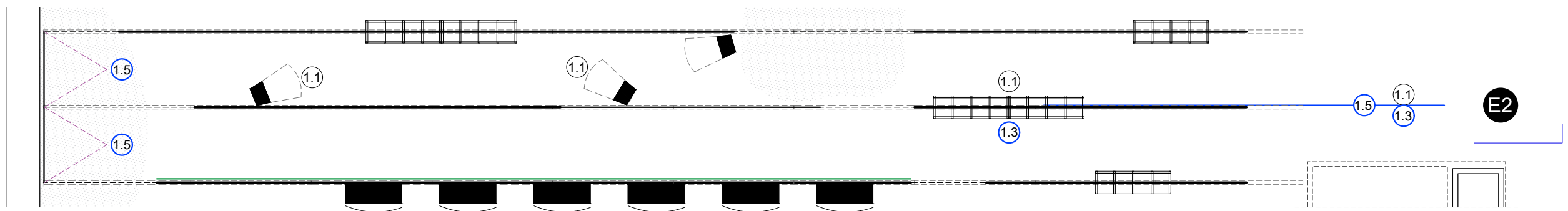

CORTINA **E**  
CONTENIDO CARA E2

0 2m 5m 10m

CORTINA E 31,9m L x 6,91 H = 220,43 m<sup>2</sup>

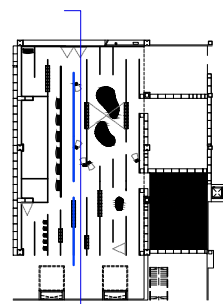
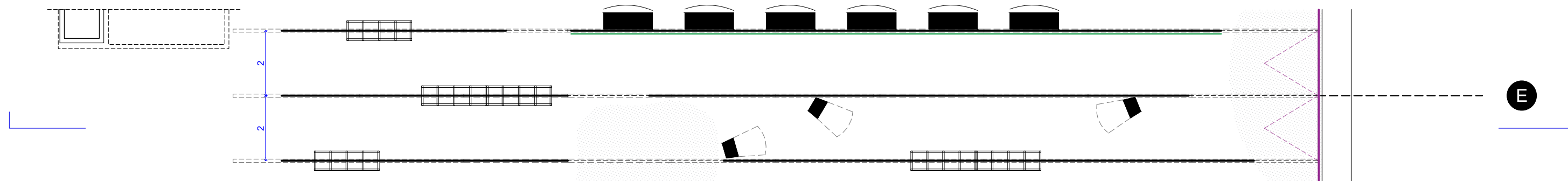
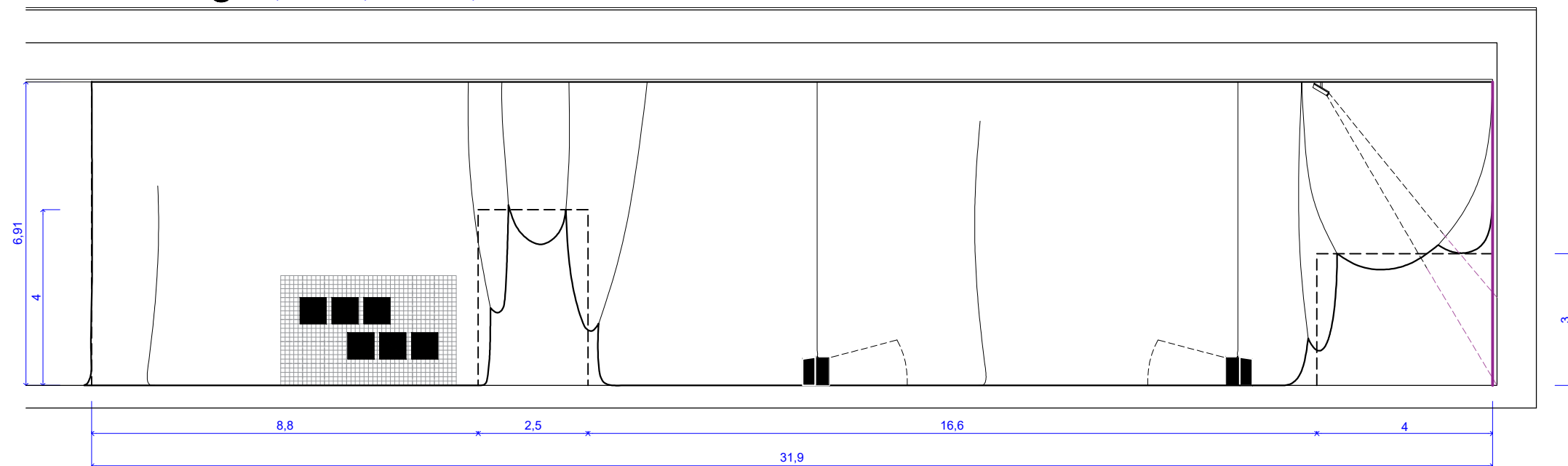

CORTINA E  
COTAS

— CORTINA IGNÍFUGA C1  
— CORTINA NEGRA DHUB

0 2m 5m 10m

CORTINA F

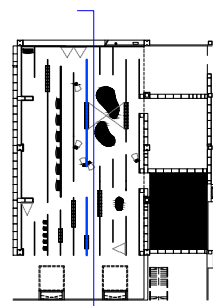
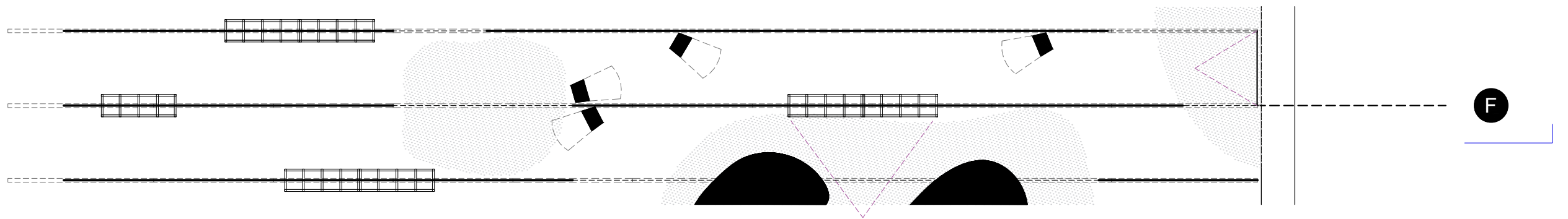
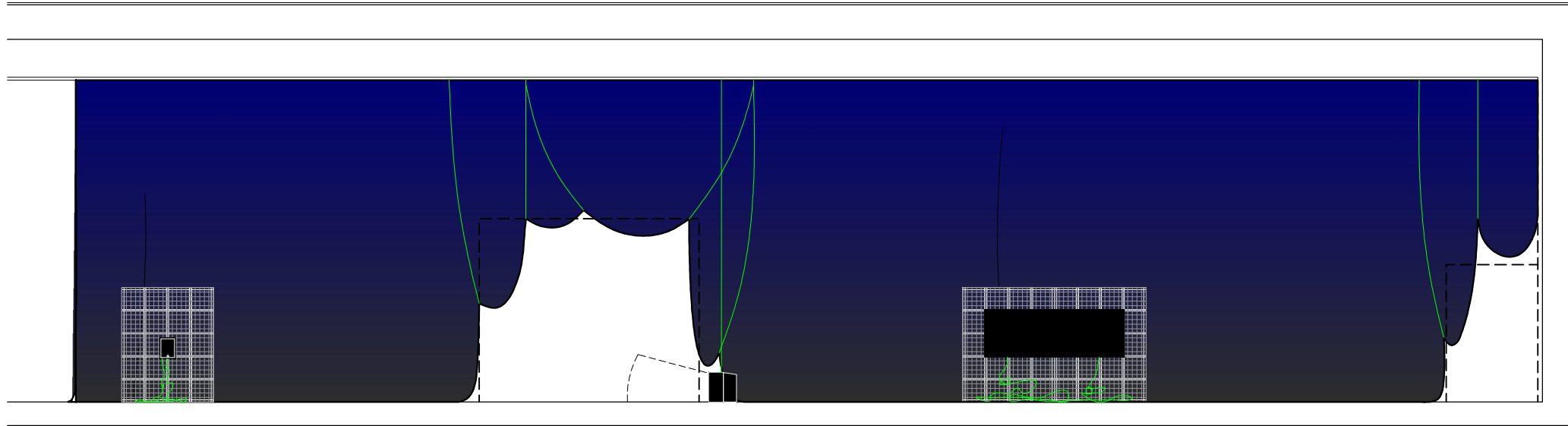

CORTINA F



CORTINA **F**

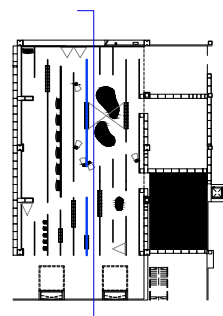
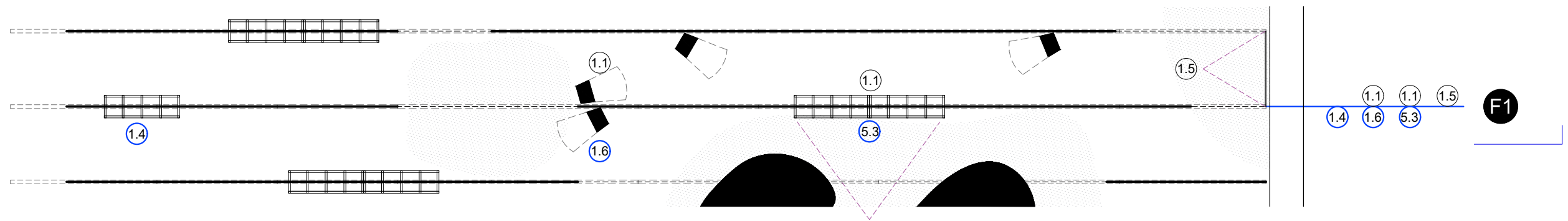
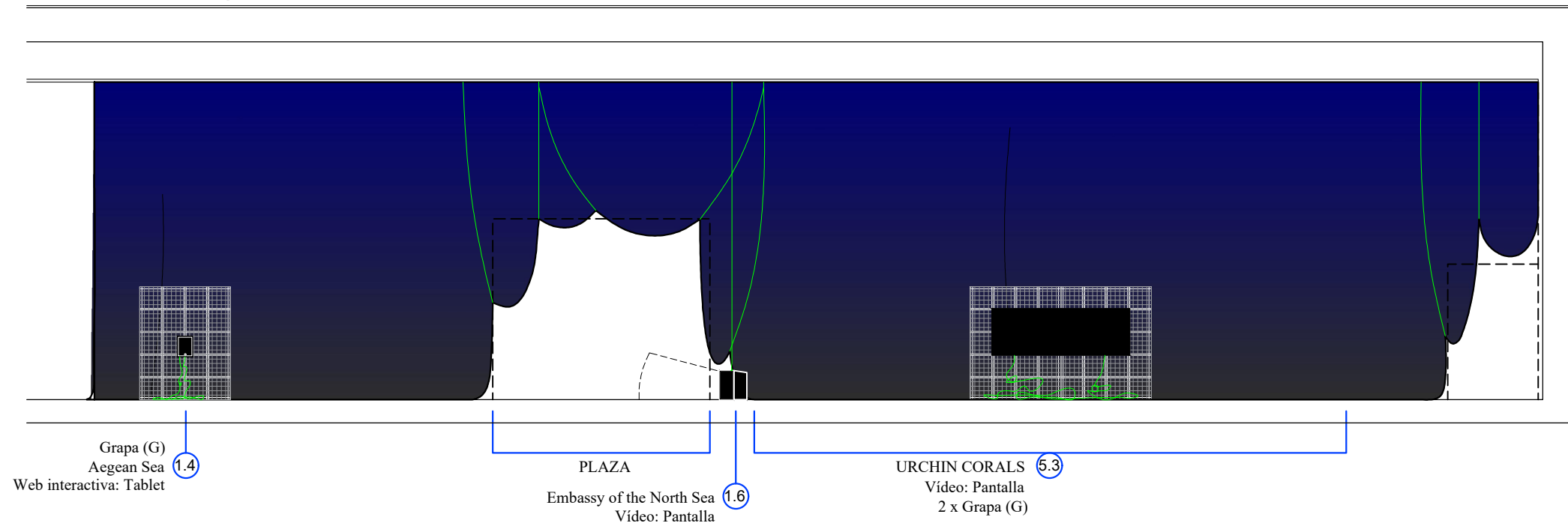

CORTINA **F**  
CONTENIDO CARA F1

0 2m 5m 10m

CORTINA **F**

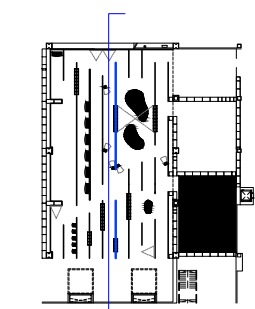
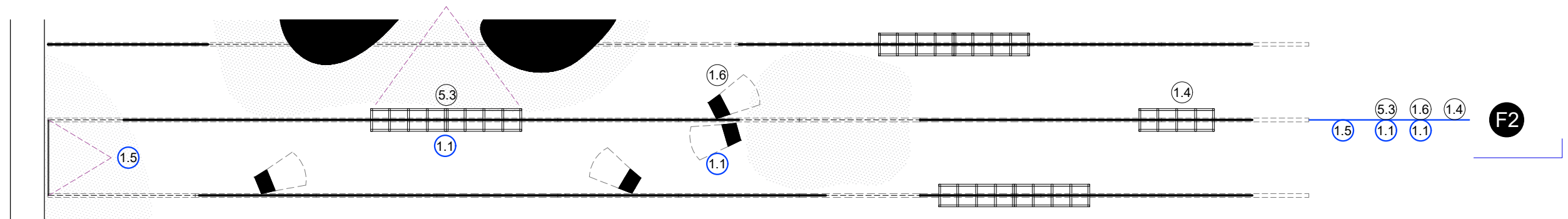
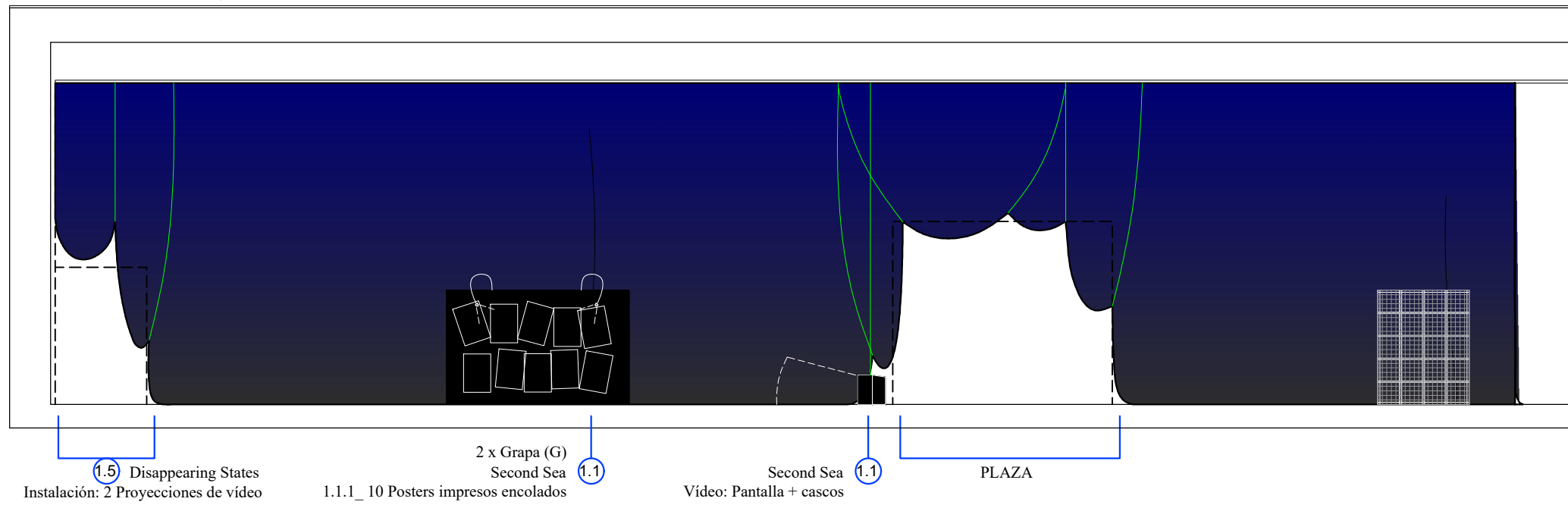

CORTINA **F**  
CONTENIDO CARA F2

0 2m 5m 10m

CORTINA **F** 31,9m L x 7,02 H = 223,94 m<sup>2</sup>

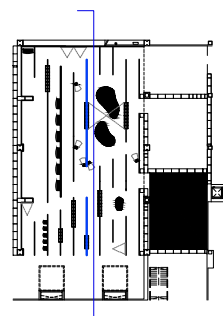
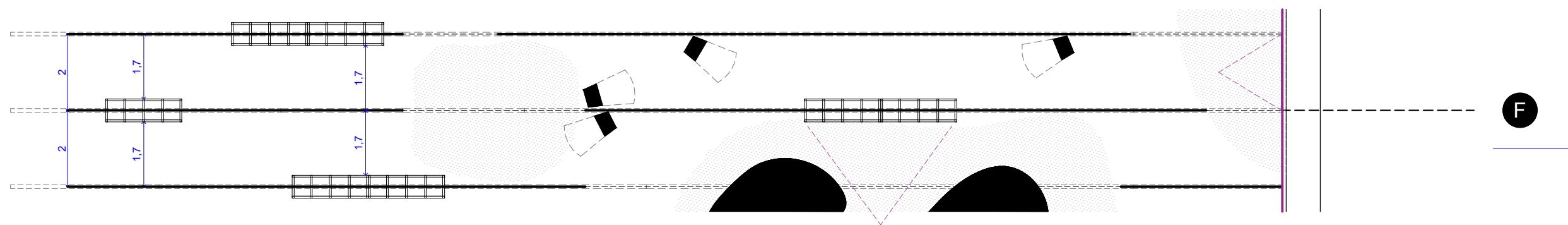
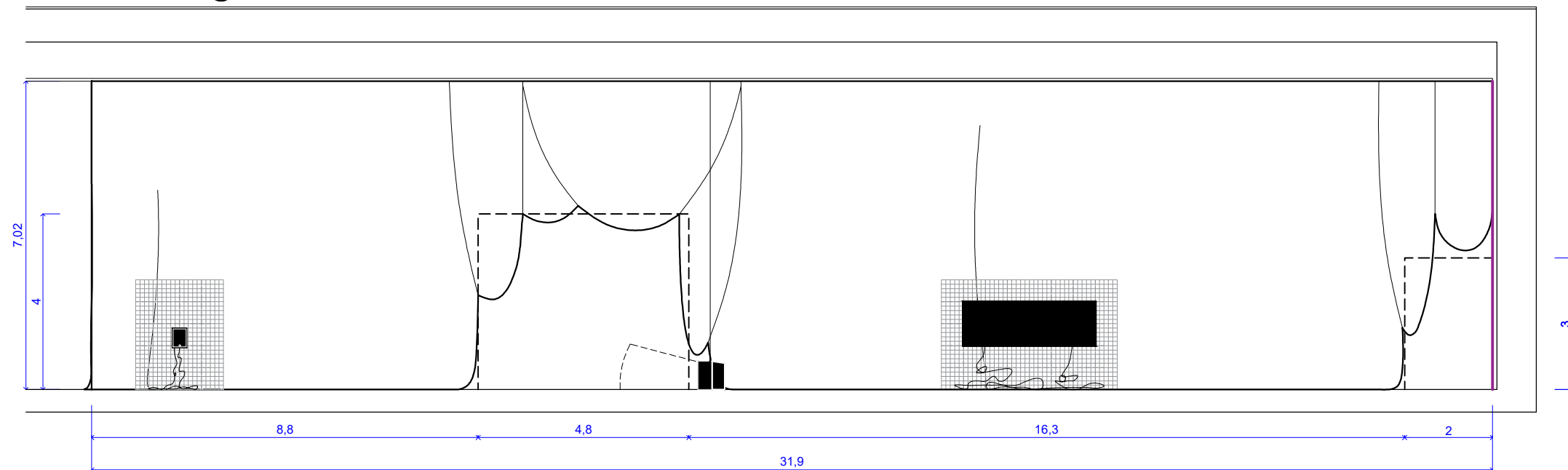

CORTINA **F**  
COTAS

0 2m 5m 10m

— CORTINA IGNÍFUGA C1  
— CORTINA NEGRA DHUB



CORTINA **G**

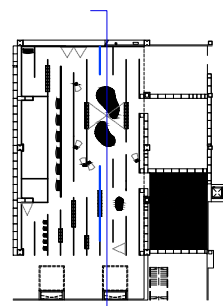
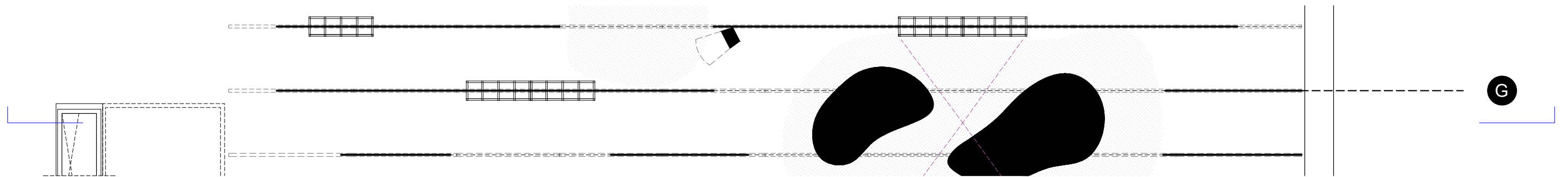
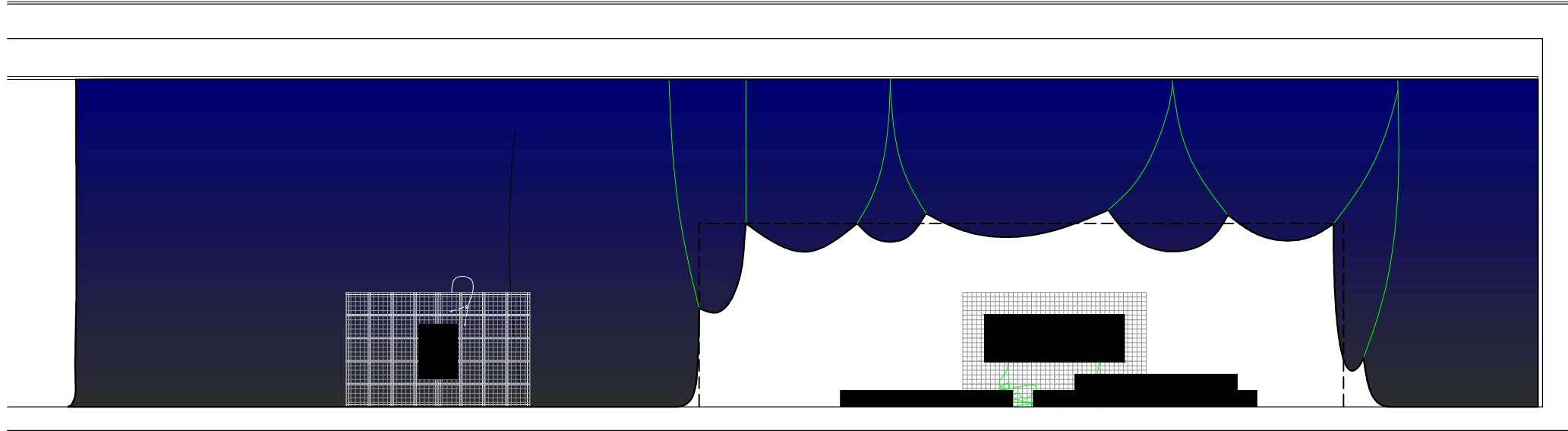

CORTINA **G**

0 2m 5m 10m

CORTINA **G**

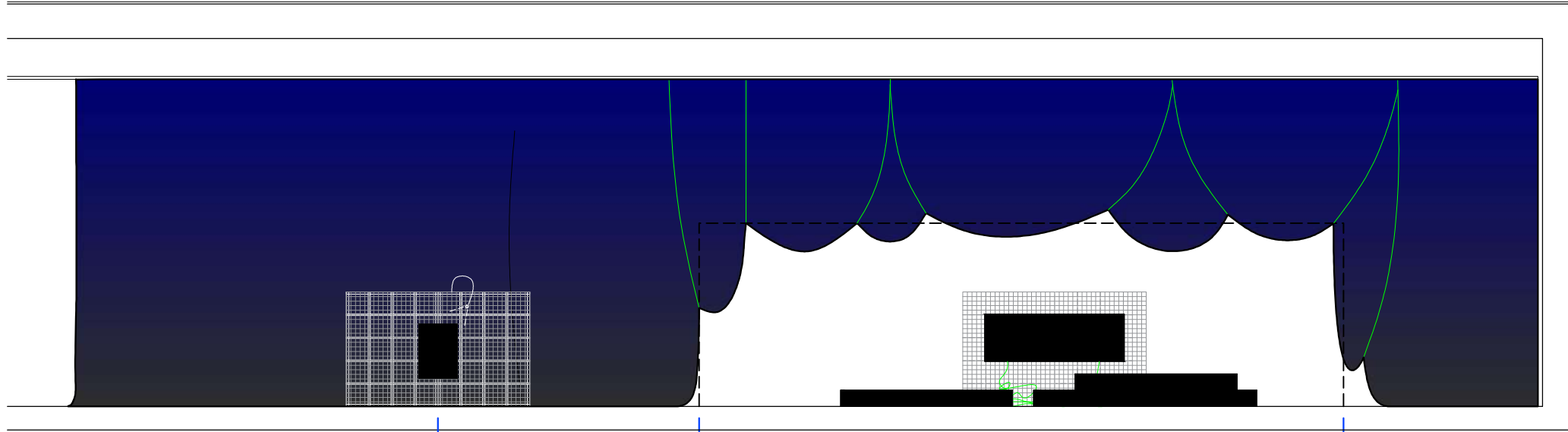

Grapa (G)  
Biotopo marino  
Panel impreso **5.2**

URCHIN CORALS **5.3**  
9 muestras de corales hechos con biopolímeros

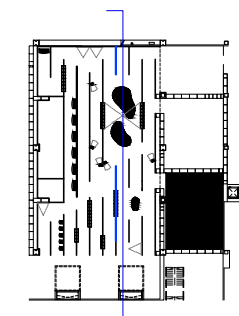
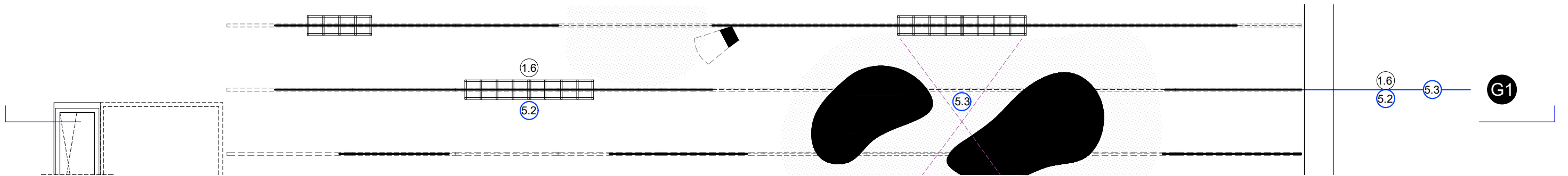

CORTINA **G**  
CONTENIDO CARA G1

0 2m 5m 10m

CORTINA **G**

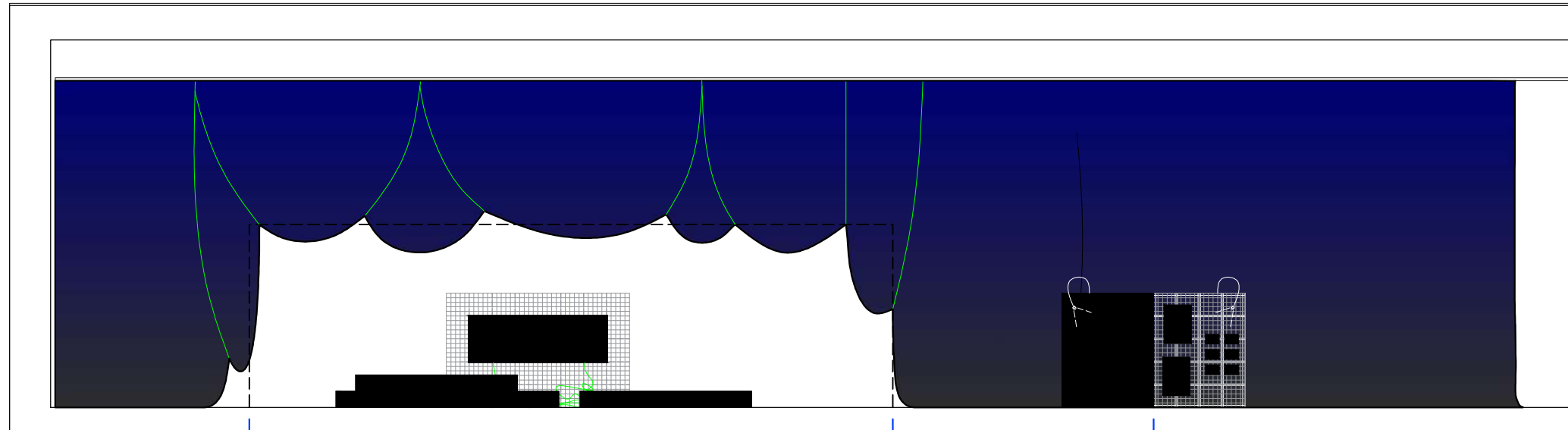

URCHIN CORALS **5.3**  
9 muestras de corales hechos con biopolímeros

**1.6**  
2 x Grapa (G)  
Embassy of the North Sea  
Instalación: Mapa-collage con pantalla y textos  
incrustedados  
2 Paneles impresos A1  
5-6 Fotografías

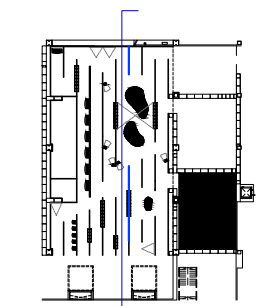
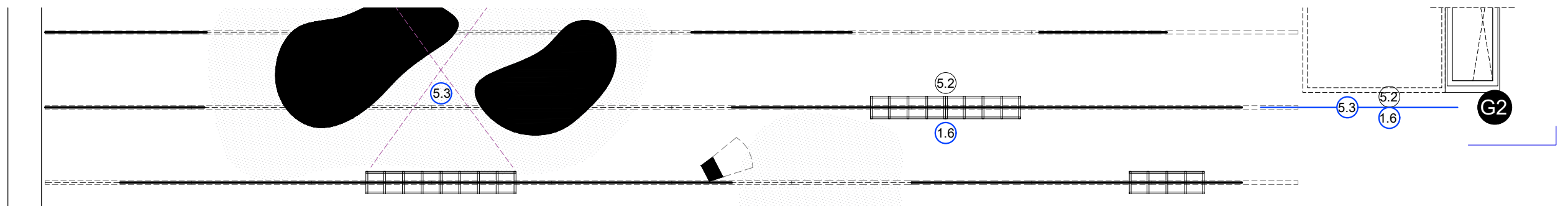

CORTINA **G**  
CONTENIDO CARA G2



CORTINA **G** 31,9m L x 7,14 H = 227,77 m<sup>2</sup>

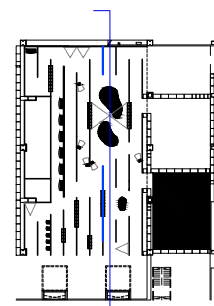
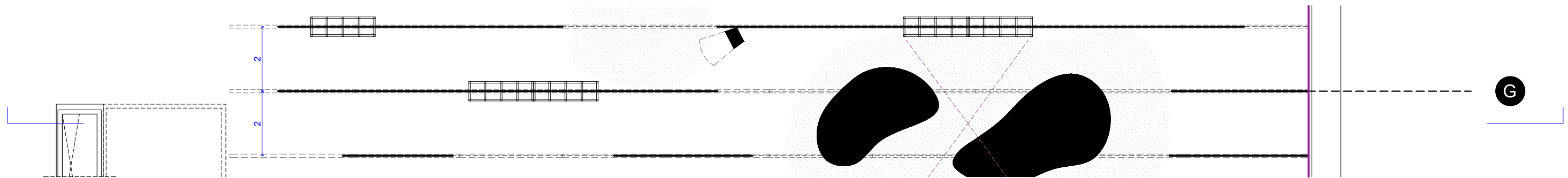
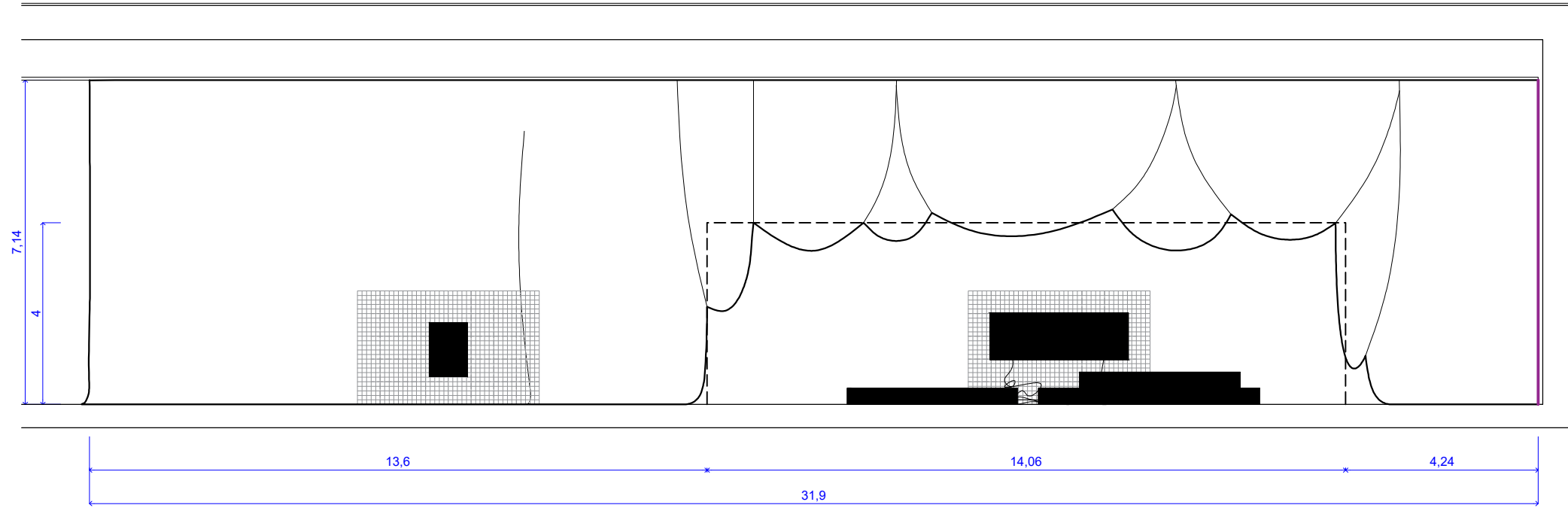

CORTINA **G**  
COTAS

0 2m 5m 10m

— CORTINA IGNÍFUGA C1  
— CORTINA NEGRA DHUB

CORTINA H

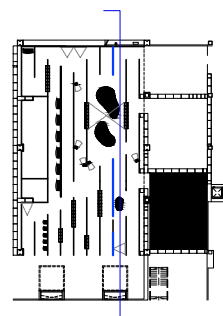
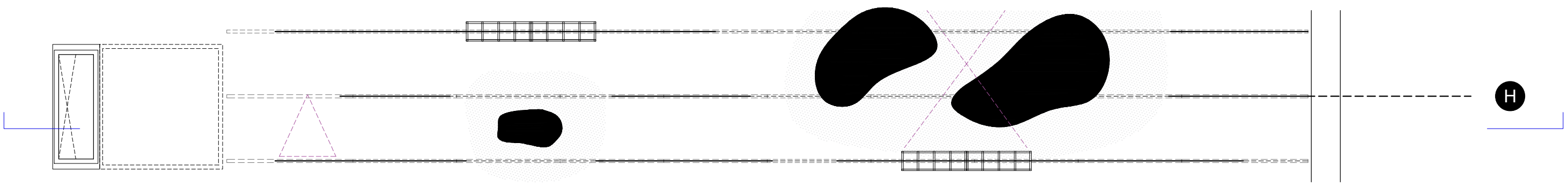
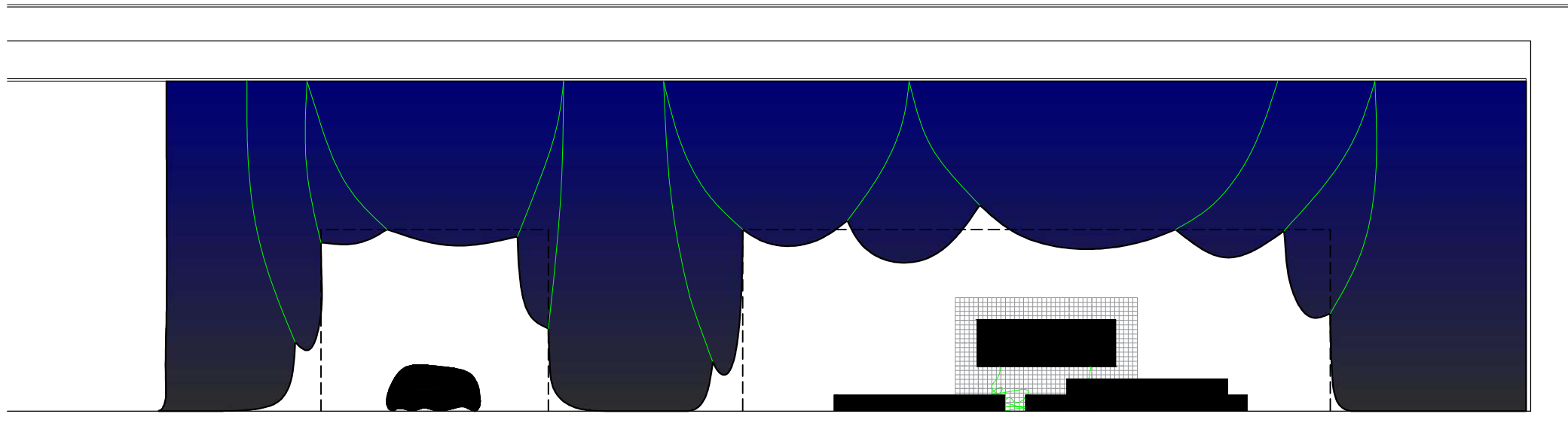

CORTINA H



CORTINA H

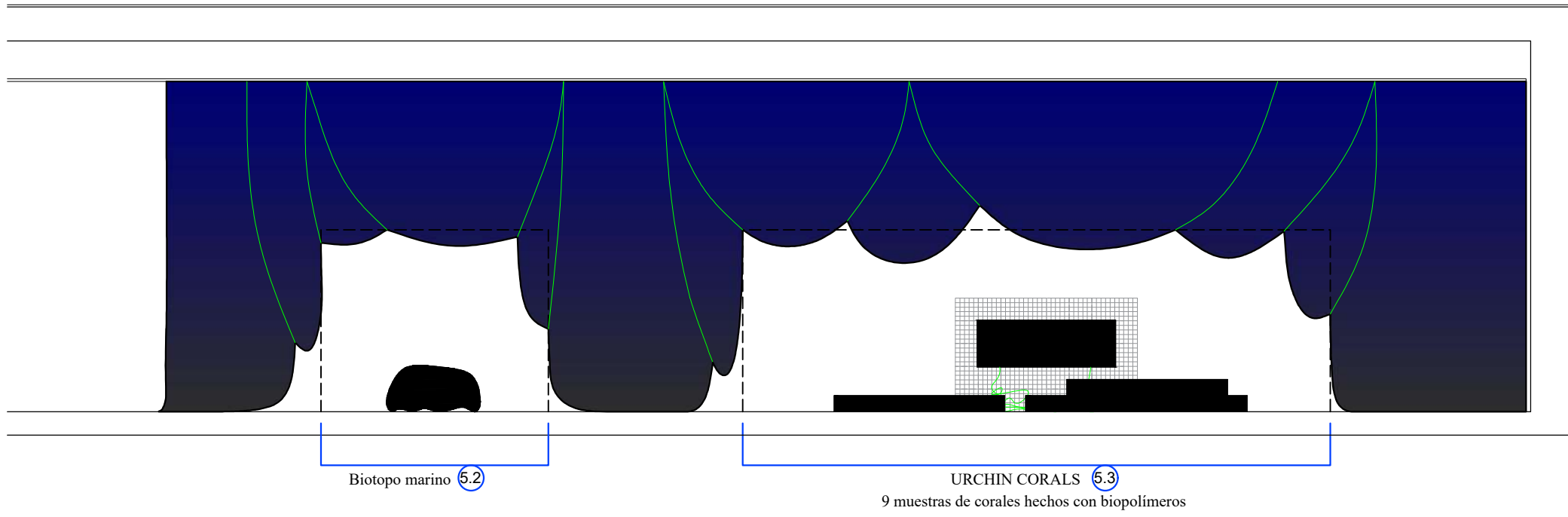

Biotopo marino 5.2

URCHIN CORALS 5.3  
9 muestras de corales hechos con biopolímeros

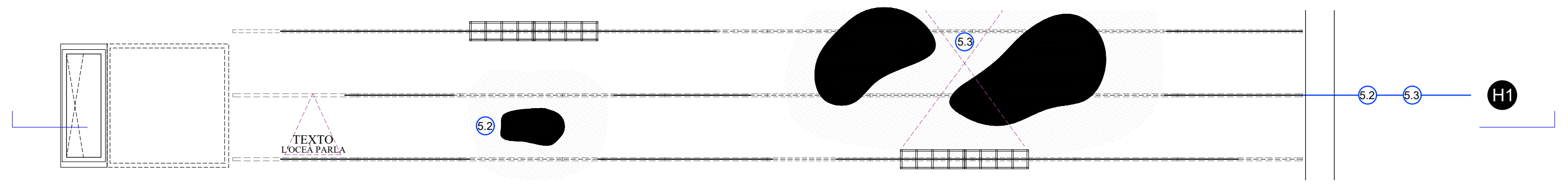

TEXTO  
L'OCÉA PARLA

5.2

5.3

5.2

5.3

H1

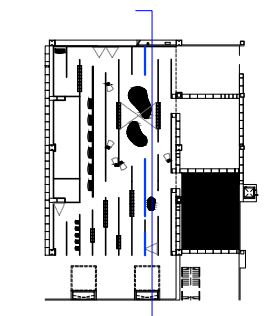

CORTINA H  
CONTENIDO CARA H1



CORTINA H

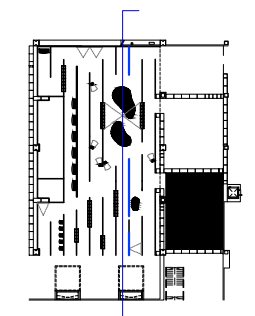
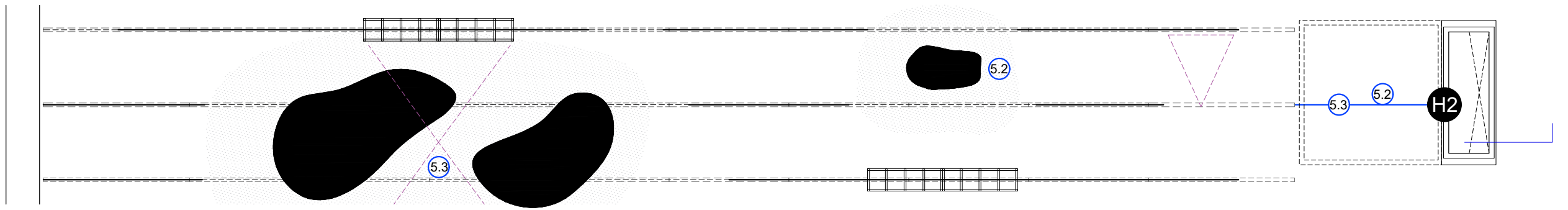
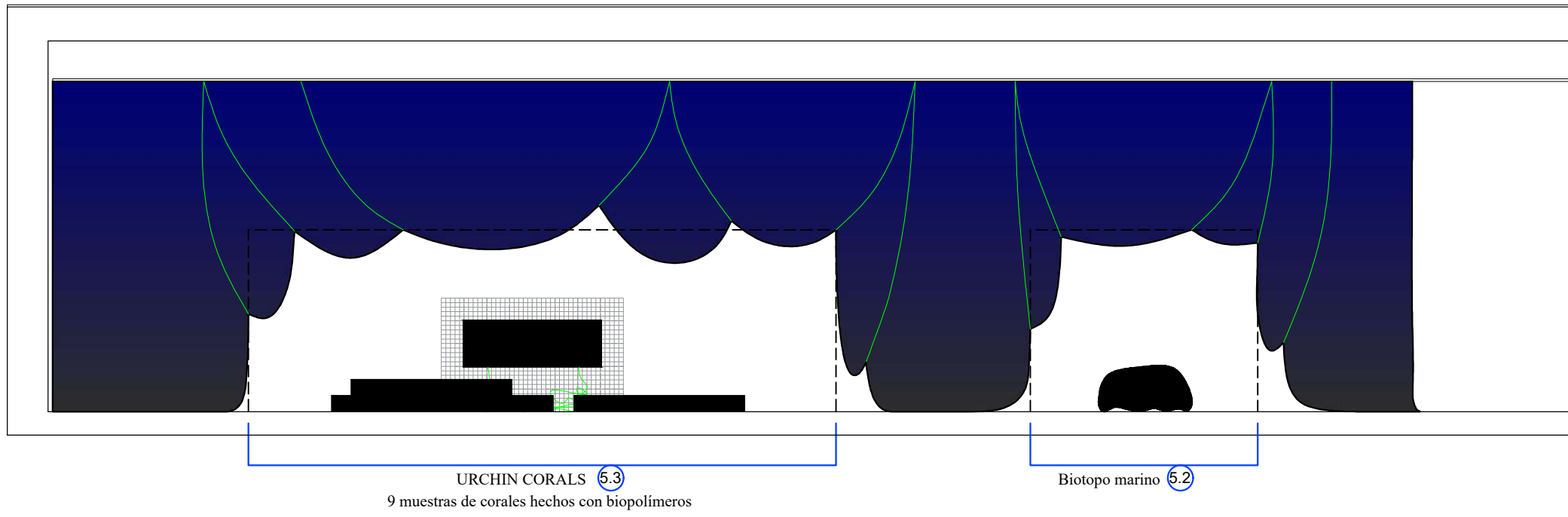

CORTINA H  
CONTENIDO CARA H2



CORTINA **H** 29,9m L x 7,26 H = 217,1 m<sup>2</sup>

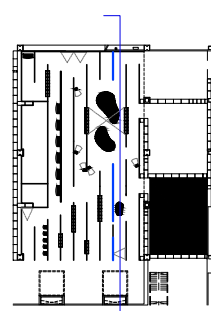
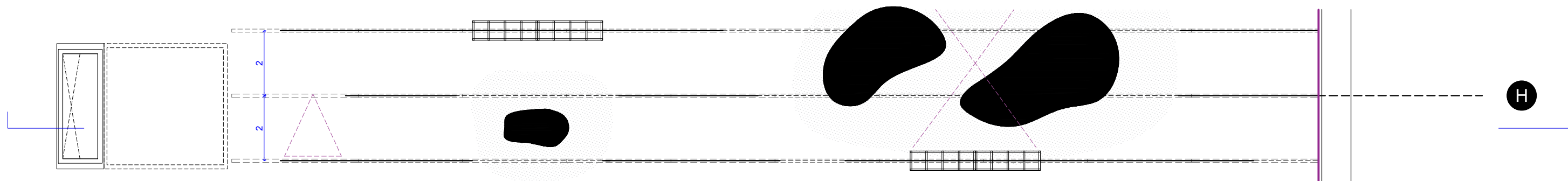
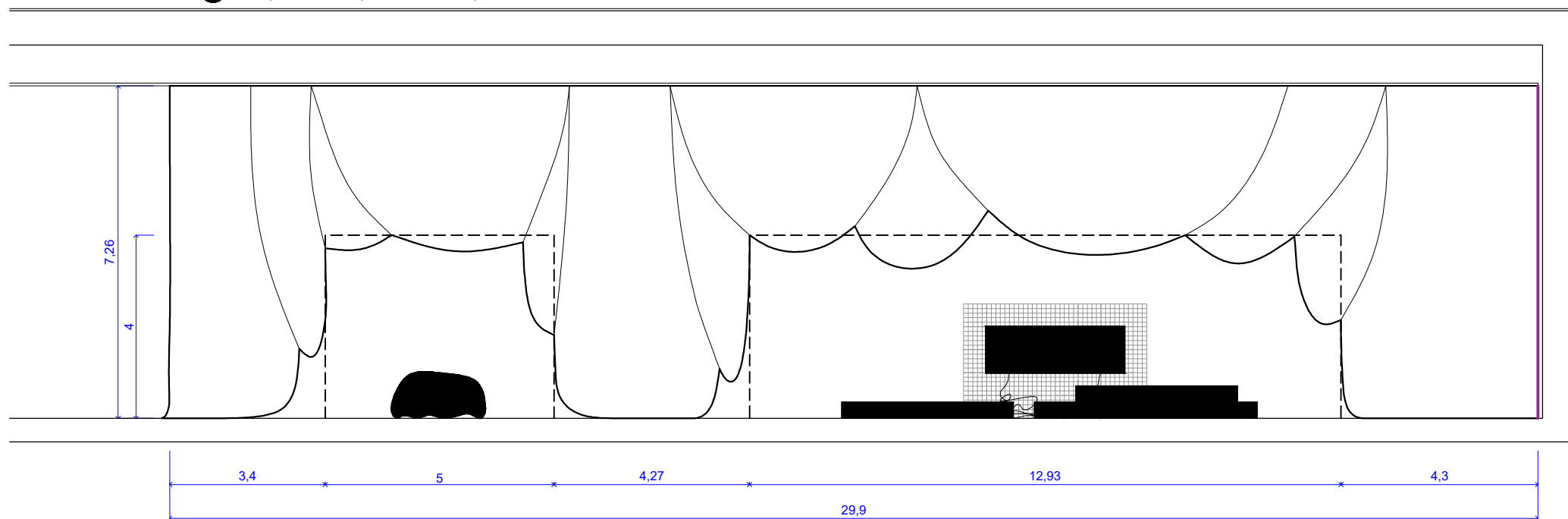

CORTINA **H**  
COTAS

0 2m 5m 10m

— CORTINA IGNÍFUGA C1  
— CORTINA NEGRA DHUB



CORTINA 1

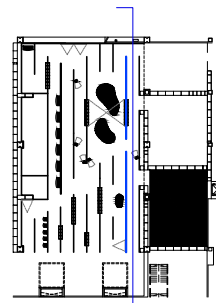
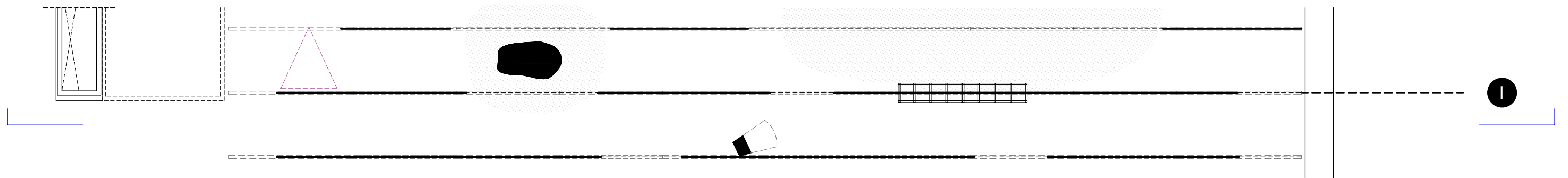
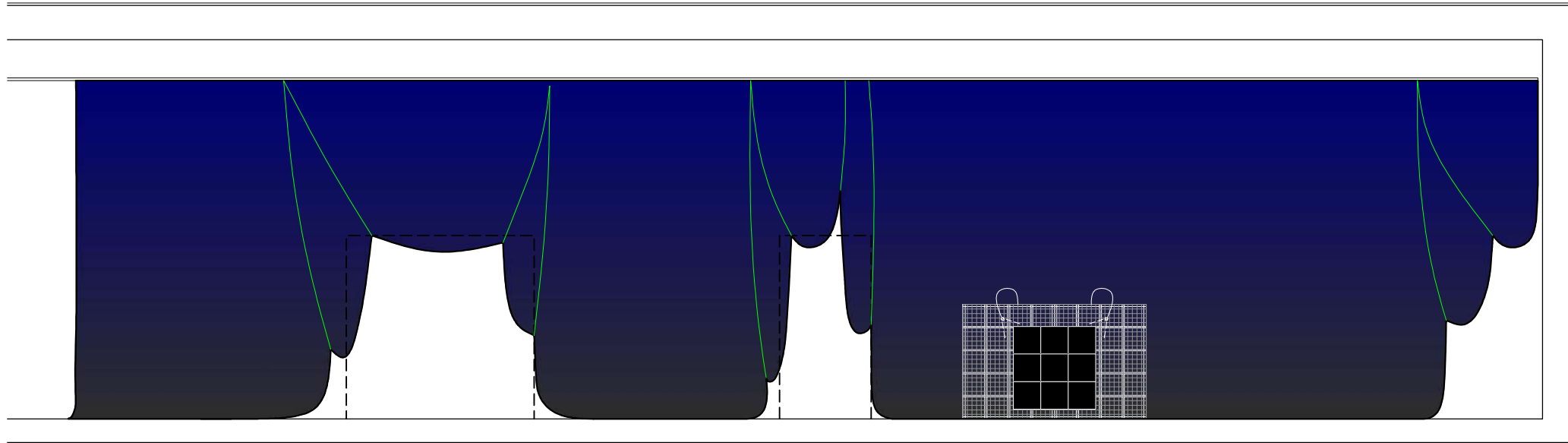

CORTINA 1



CORTINA 1

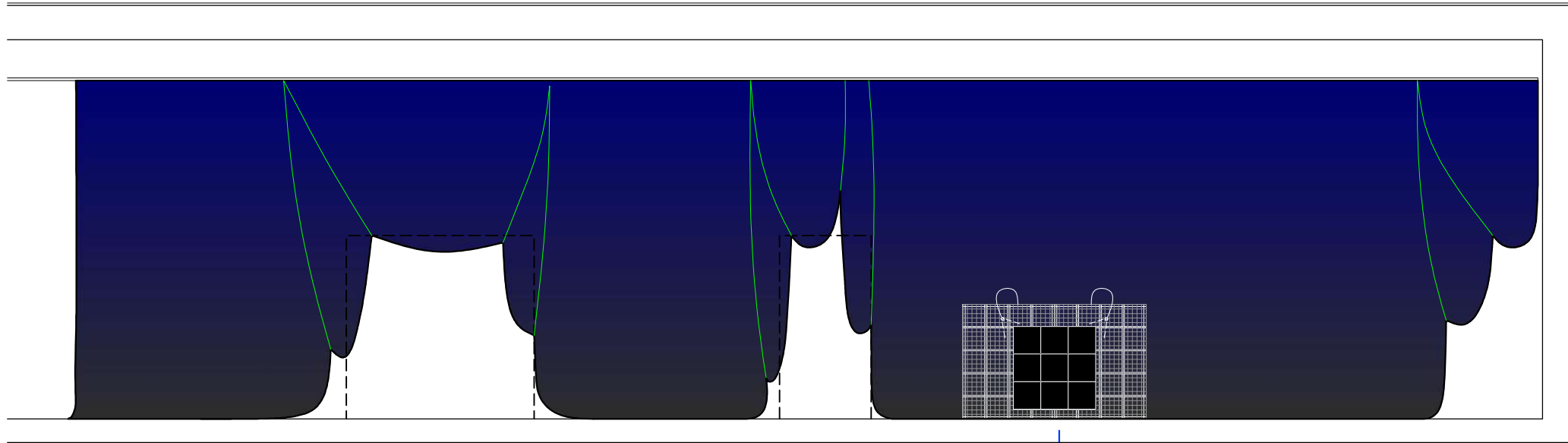

- 4.1 2 x Grapa (G)
- 4.1 Pacific Aquarium
- 9 Dibujos impresos sobre tela de algodón

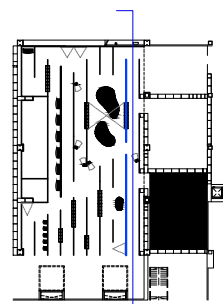
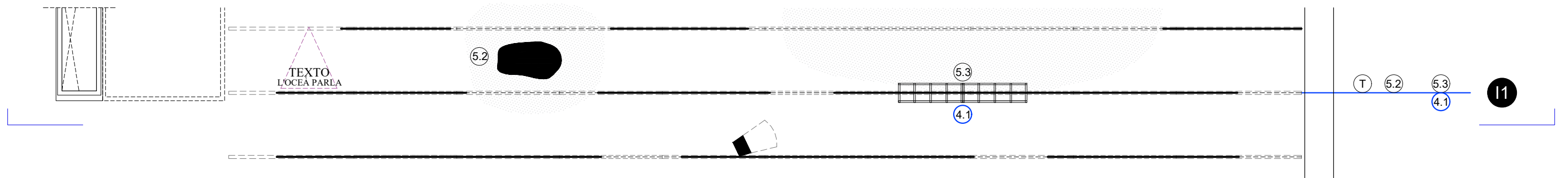

CORTINA 1  
CONTENIDO CARA II



CORTINA 1

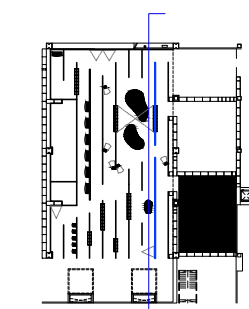
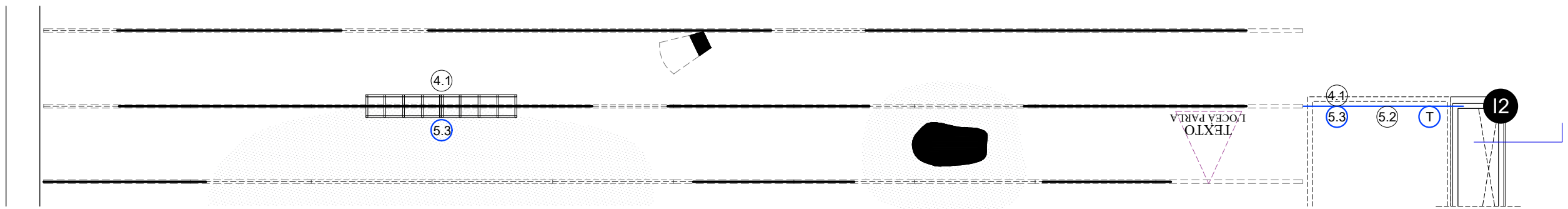
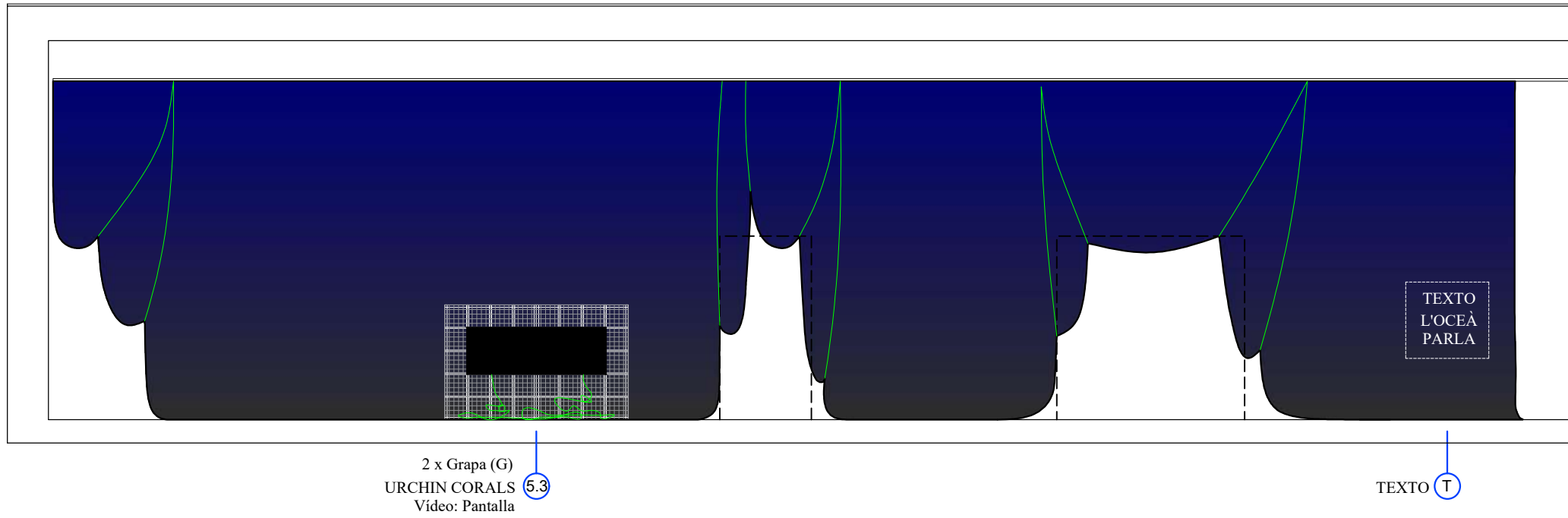

CORTINA 1  
CONTENIDO CARA I2



CORTINA 1 31,9m L x 7,38 H = 235,42 m<sup>2</sup>

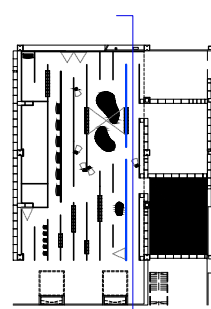
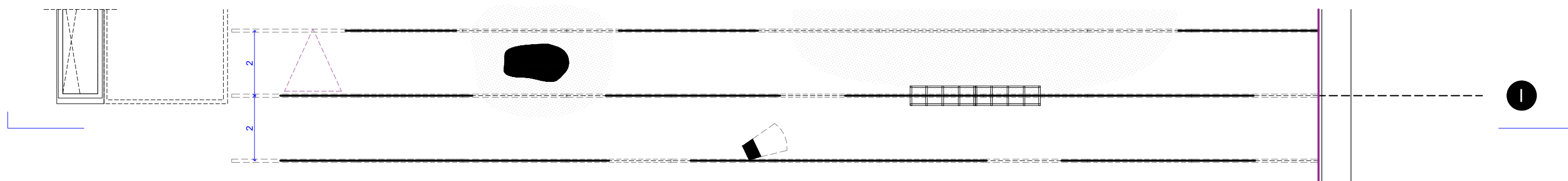
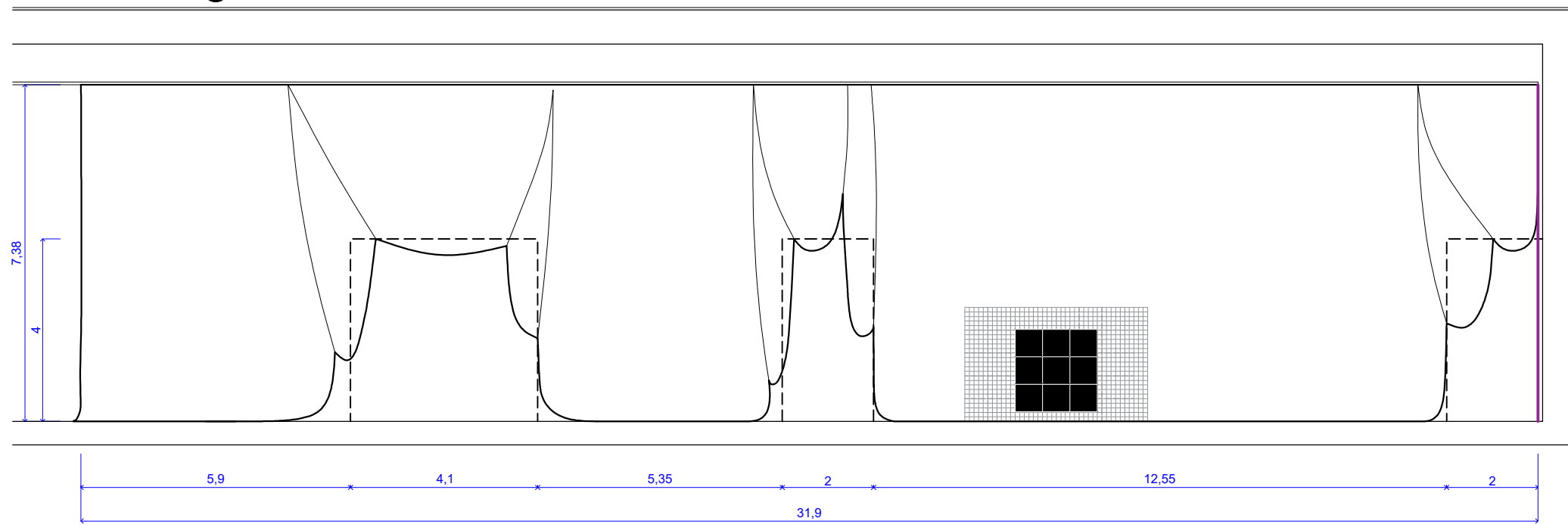

CORTINA 1  
COTAS

0 2m 5m 10m

— CORTINA IGNÍFUGA C1  
— CORTINA NEGRA DHUB

CORTINA **J**

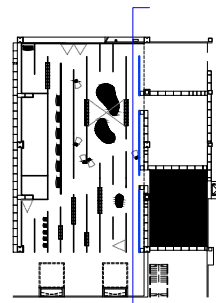
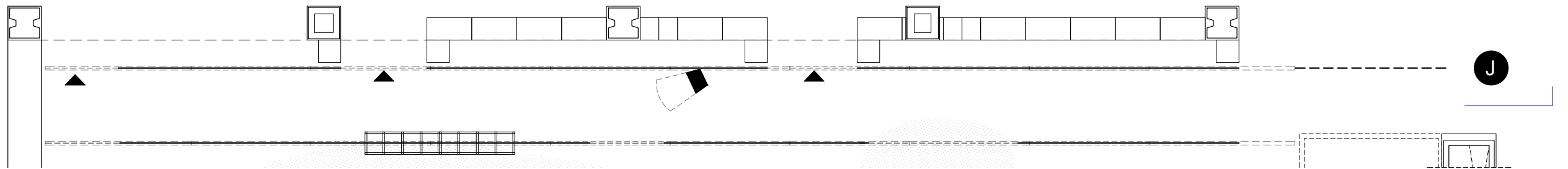
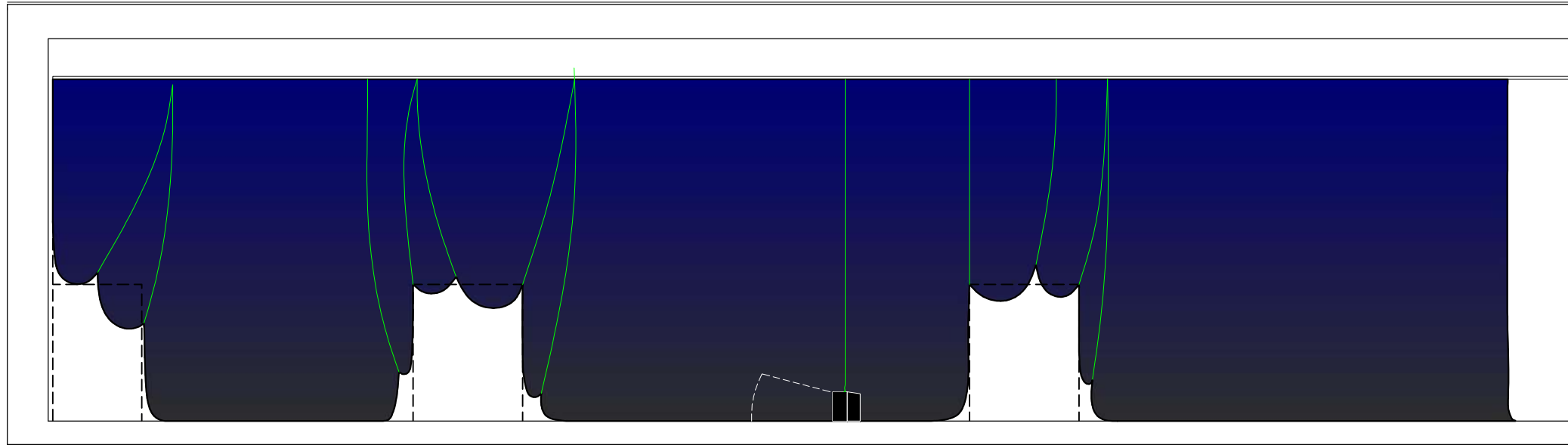

CORTINA **J**



CORTINA **J**

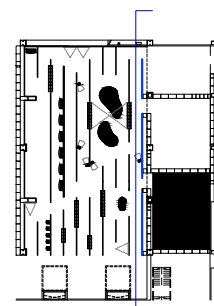
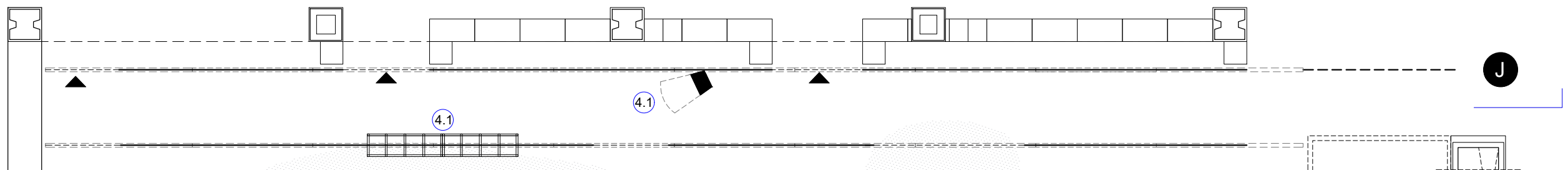
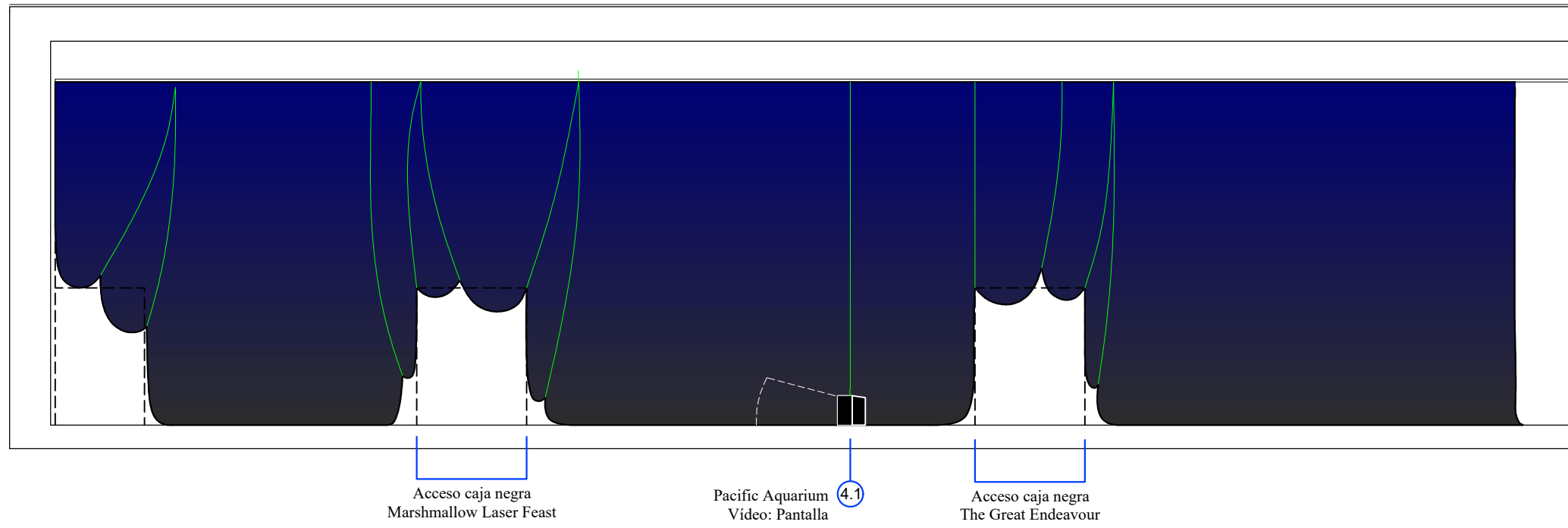

CORTINA **J**  
CONTENIDO



CORTINA **J** 31,9m L x 7,5 H = 239,25 m2

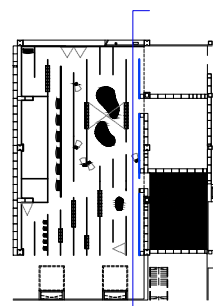
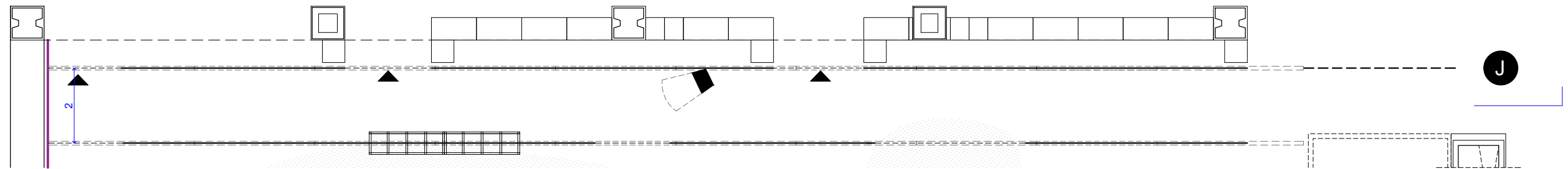
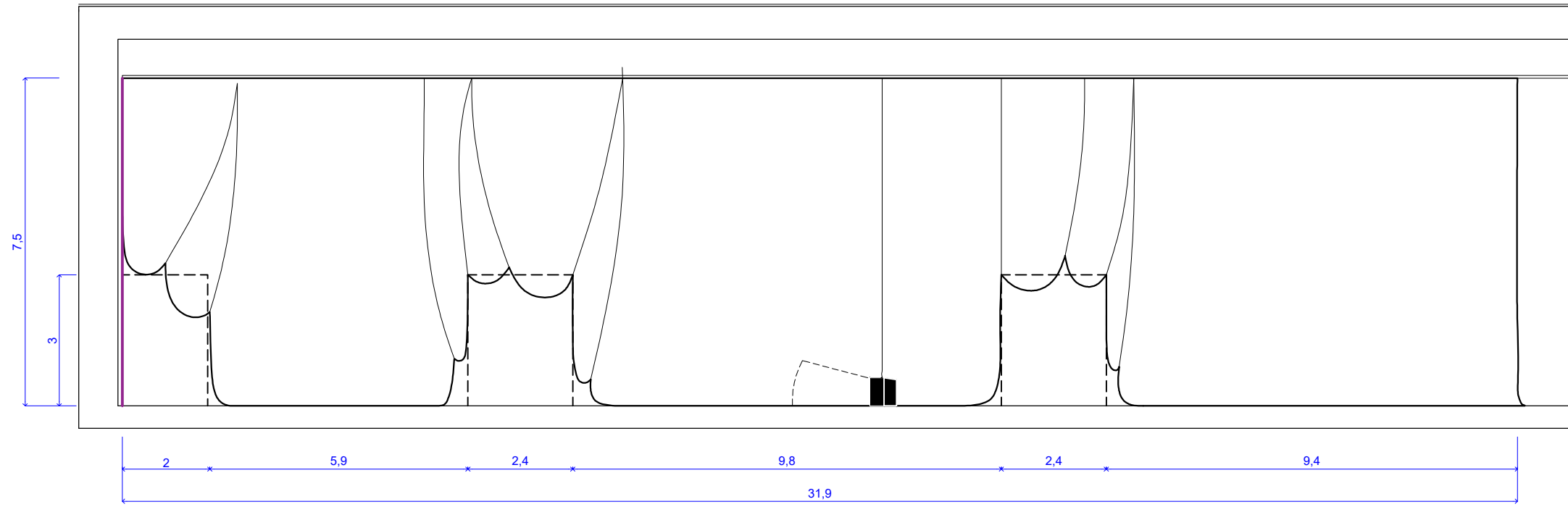

CORTINA **J**  
COTAS



- CORTINA IGNÍFUGA
- CORTINA NEGRA DHUB

## 4. PLANIMETRÍA: OTROS



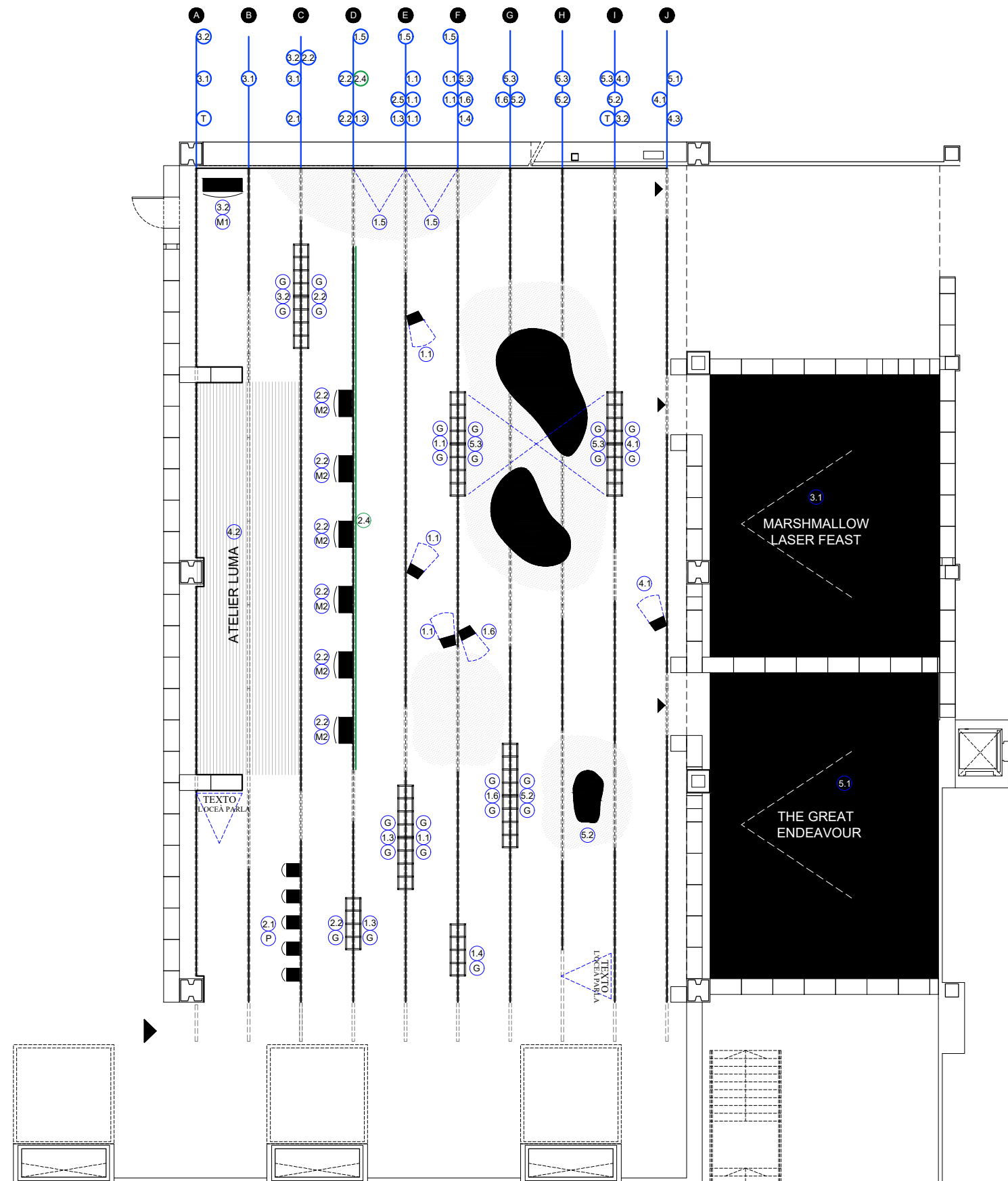

- CORTINA A**
  - 3.2 1 x MESA (M1) 150x50x75cm con punto de luz LED
- CORTINA B**
  - 4.2 ATELIER LUMA
    - 2 x MESA (M1) 1,5x0,5x0,75m con punto de luz LED
    - 1 x ELEMENTO VERTICAL GRAPA (G) 1
    - Módulo 200x50x250m con punto de luz LED
- CORTINA C**
  - 2.1 5 x PEANA (P1) 50x50x100m con puntos de luz LED
  - 3.2 2.2 2 x ELEMENTO VERTICAL GRAPA (G) 2 Módulos 200x50x250m con puntos de luz LED
- CORTINA D**
  - 2.2 1.3 1 x ELEMENTO VERTICAL GRAPA (G) 1 Módulo 200x50x250m con puntos de luz LED
  - 2.2 6 x MESA (M2) 150x50x100m con punto de luz LED
  - 2.4 Cortina serigrafiada Guía de la Barcelona Sumergida
- CORTINA E**
  - 1.3 1.1 2 x ELEMENTO VERTICAL GRAPA (G) 2 Módulos 200x50x250m con puntos de luz LED
  - 1.1 2 x PANTALLA apoyada en suelo
  - 1.5 2 x PROYECTOR a superficie 4m ancho x2m alto (Instalación Disappearing States)
- CORTINA F**
  - 1.4 1 x ELEMENTO VERTICAL GRAPA (G) 1 Módulo 200x50x250m
  - 1.1 1.6 2 x PANTALLA apoyada en suelo
  - 1.1 5.3 2 x ELEMENTO VERTICAL GRAPA (G) 2 Módulos 200x50x250m con puntos de luz LED
- CORTINA G**
  - 1.6 5.2 2 x ELEMENTO VERTICAL GRAPA (G) 2 Módulos 200x50x250m con puntos de luz LED
  - 5.3 2 x VOLÚMENES (Urchin Corals)
- CORTINA H**
  - 5.2 1 x VOLUMEN (Biotopo marino)
  - 5.3 2 x VOLÚMENES (Urchin Corals)
- CORTINA I**
  - 5.3 4.1 2 x ELEMENTO VERTICAL GRAPA (G) 2 Módulos 200x50x250m con puntos de luz LED
- CORTINA J**
  - 4.1 1 x PANTALLA apoyada en suelo

PLANTA DISPOSITIVOS  
PLANTA

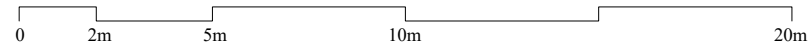

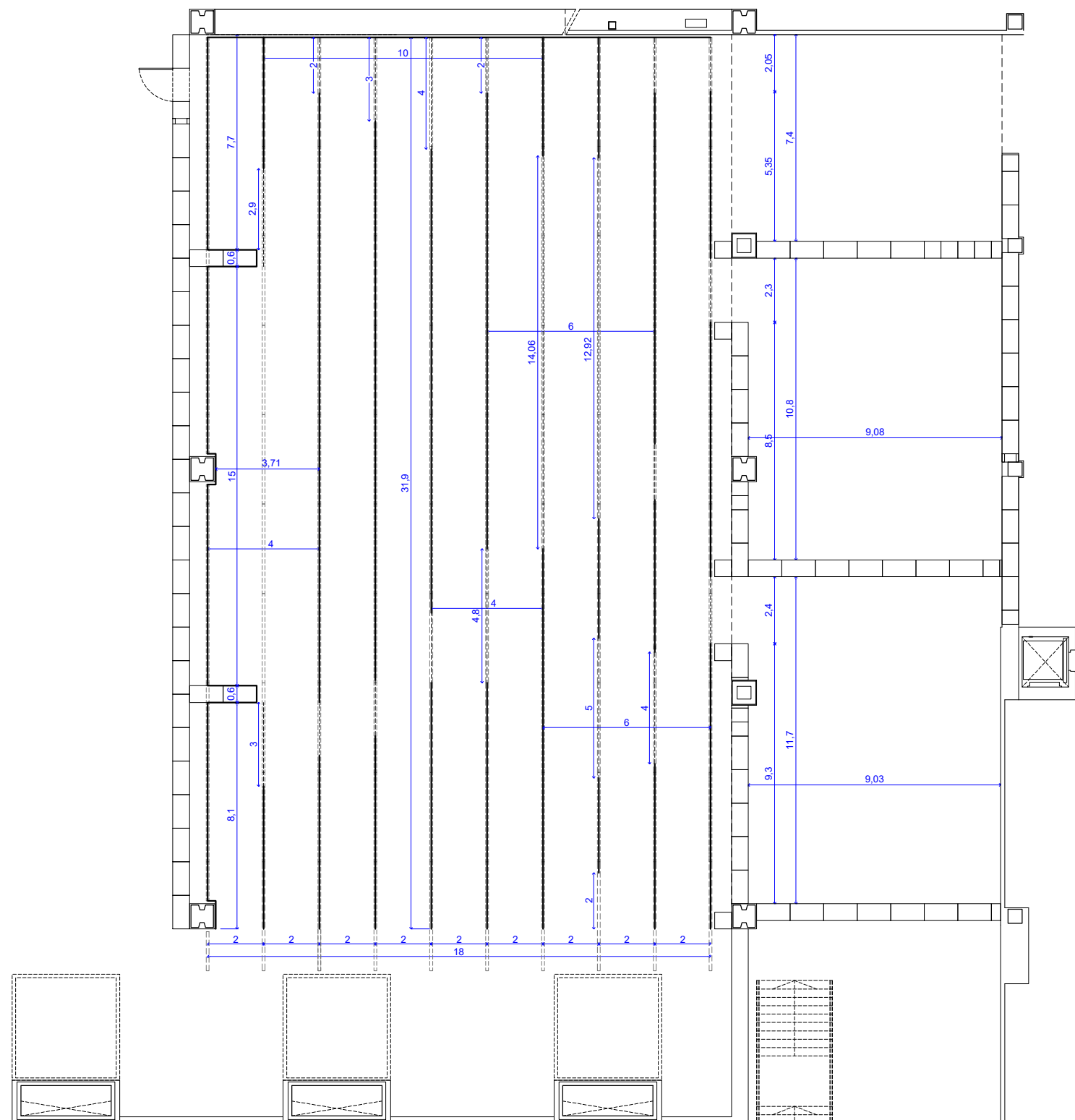

— CORTINAS TEJIDO IGNIFUGO C1

COTAS  
PLANTA

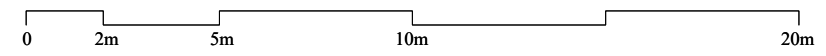

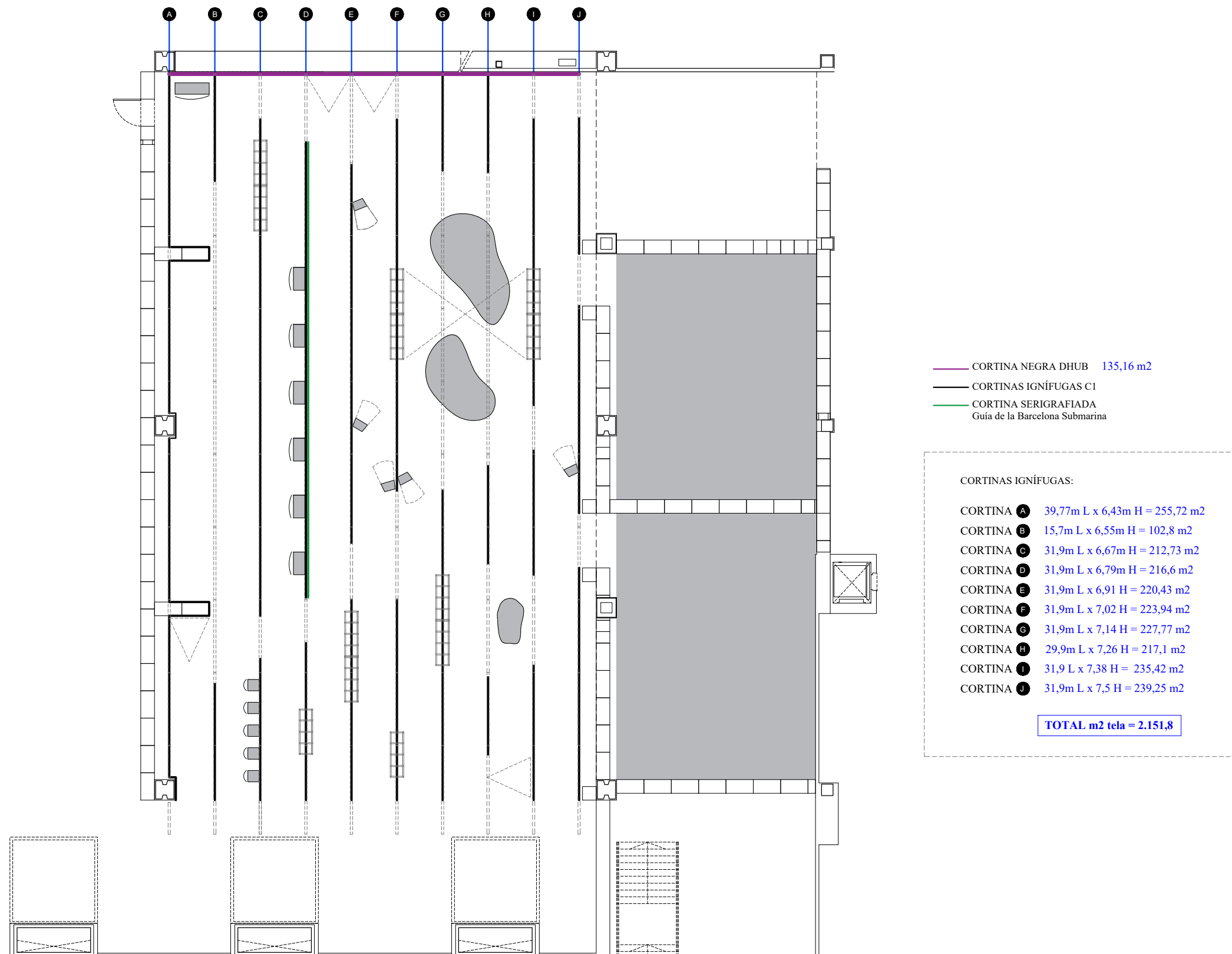

CORTINAS  
PLANTA

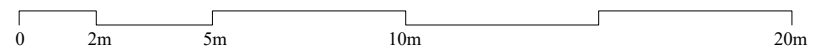

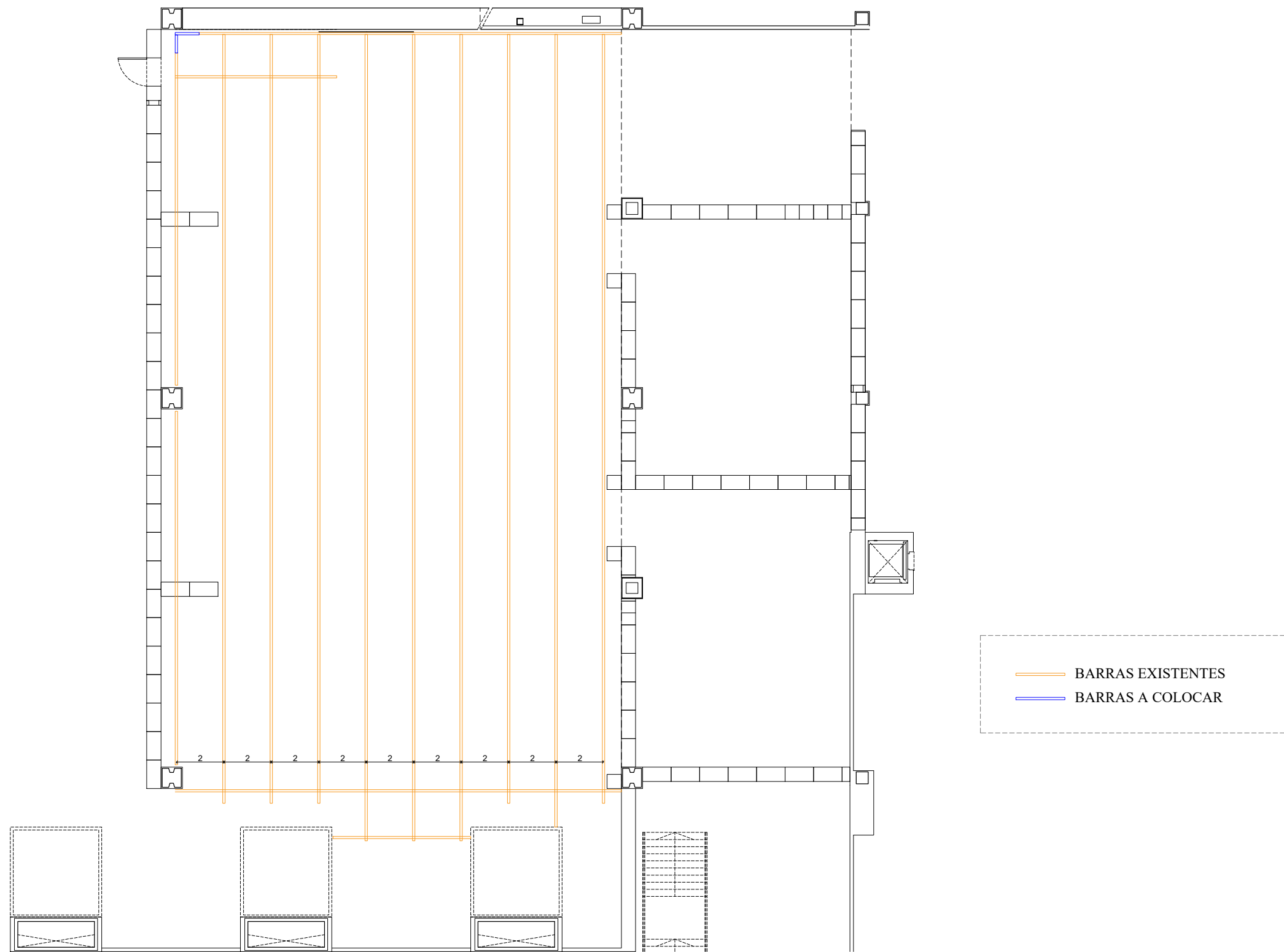

BARRAS TUBULARES  
PLANTA

0 2m 5m 10m 20m

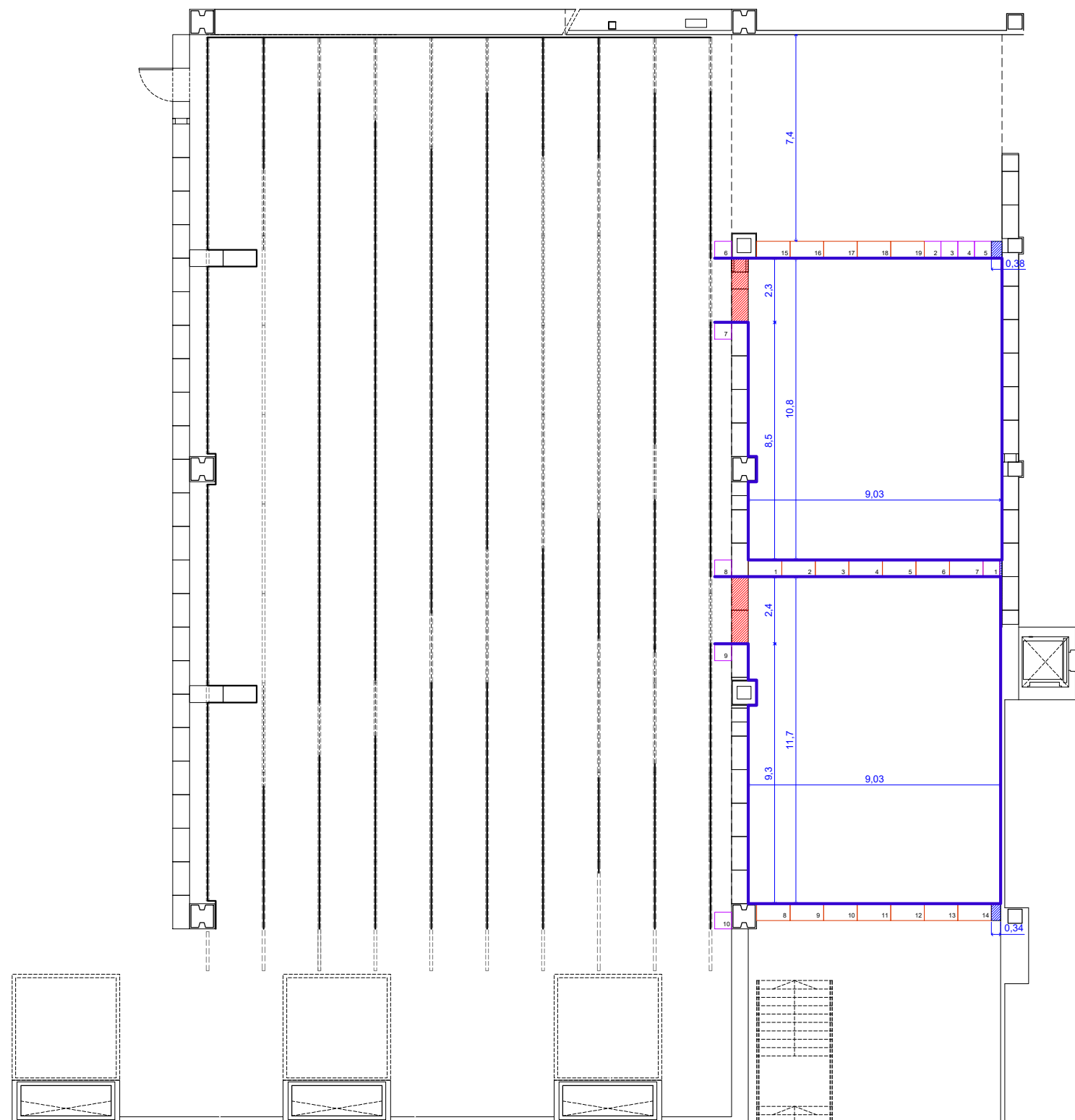

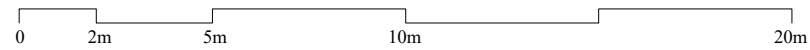

- Muros desmontados
- PM 120 Muros 120x60 H:320 x19 unidades (15 stock + 4 desmontados)
- PM 60 Muros 60x60 H:320 x10 unidades
- PT A completar
- Empapelado y acabado con pintura plástica acrílica

Muros Modulares Móviles  
Planta

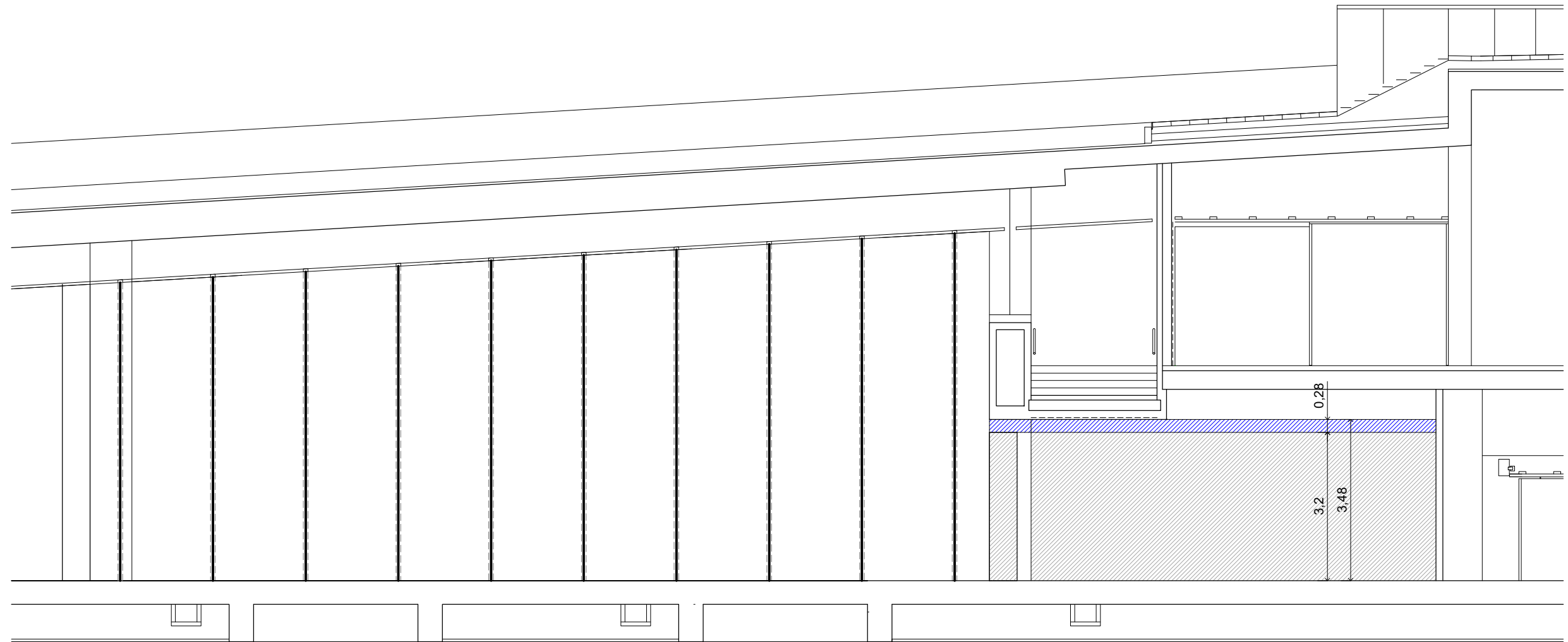



-  Altura muros modulares móviles
- PT  Huevo a completar

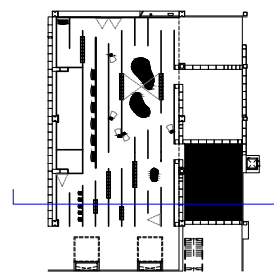

MUROS MODULARES MÓVILES  
SECCIÓN



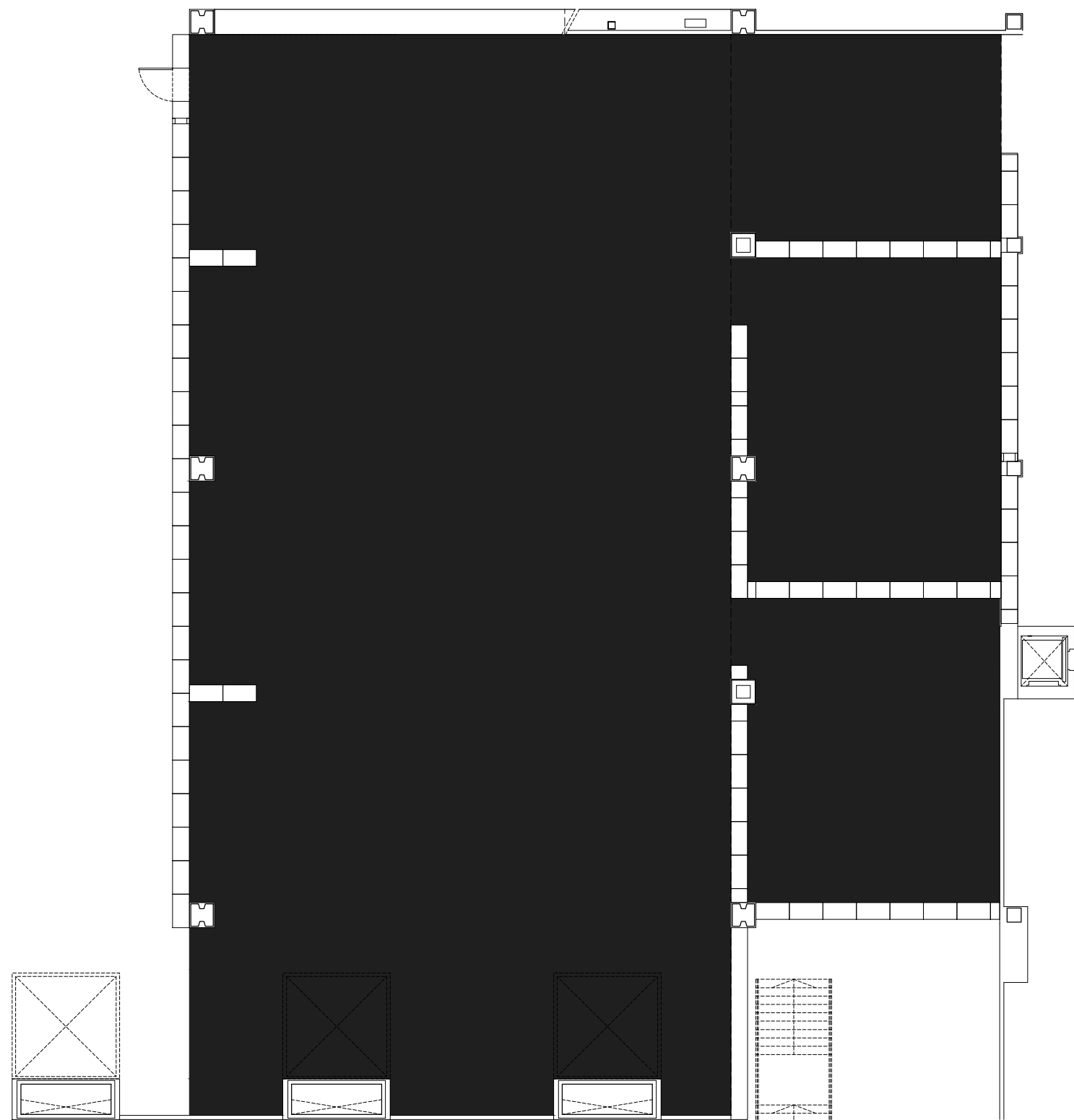

■ 1.014 m<sup>2</sup> PAVIMENTO DE MOQUETA

PAVIMENTO  
PLANTA

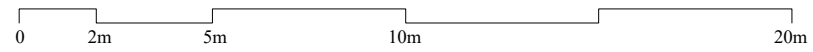

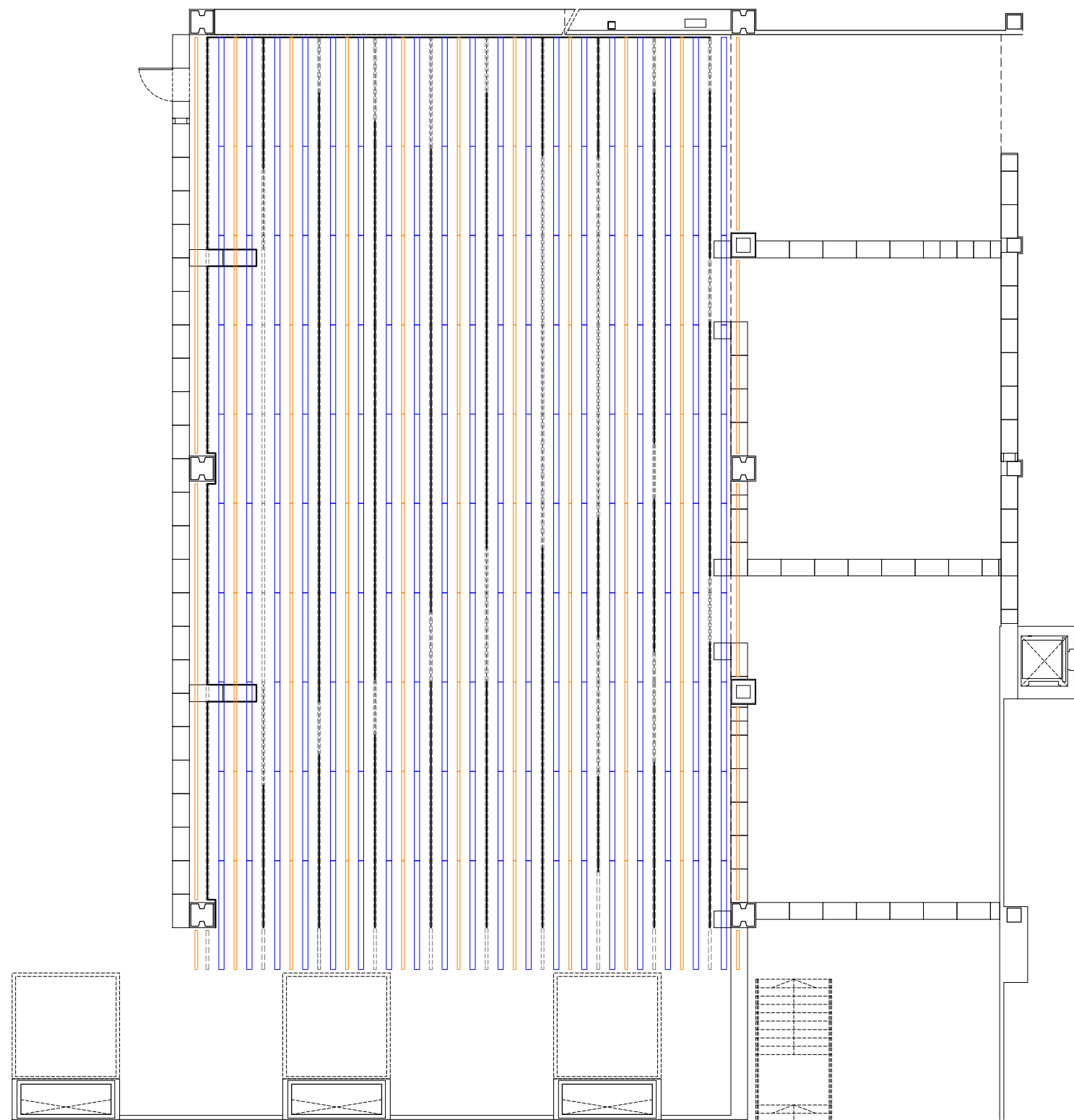

CARRIL ILUMINACIÓN ERCO  
LUMINARIA LINEAL TUBO LED RGB

ILUMINACIÓN: TECHO  
PLANTA

0 2m 5m 10m 20m



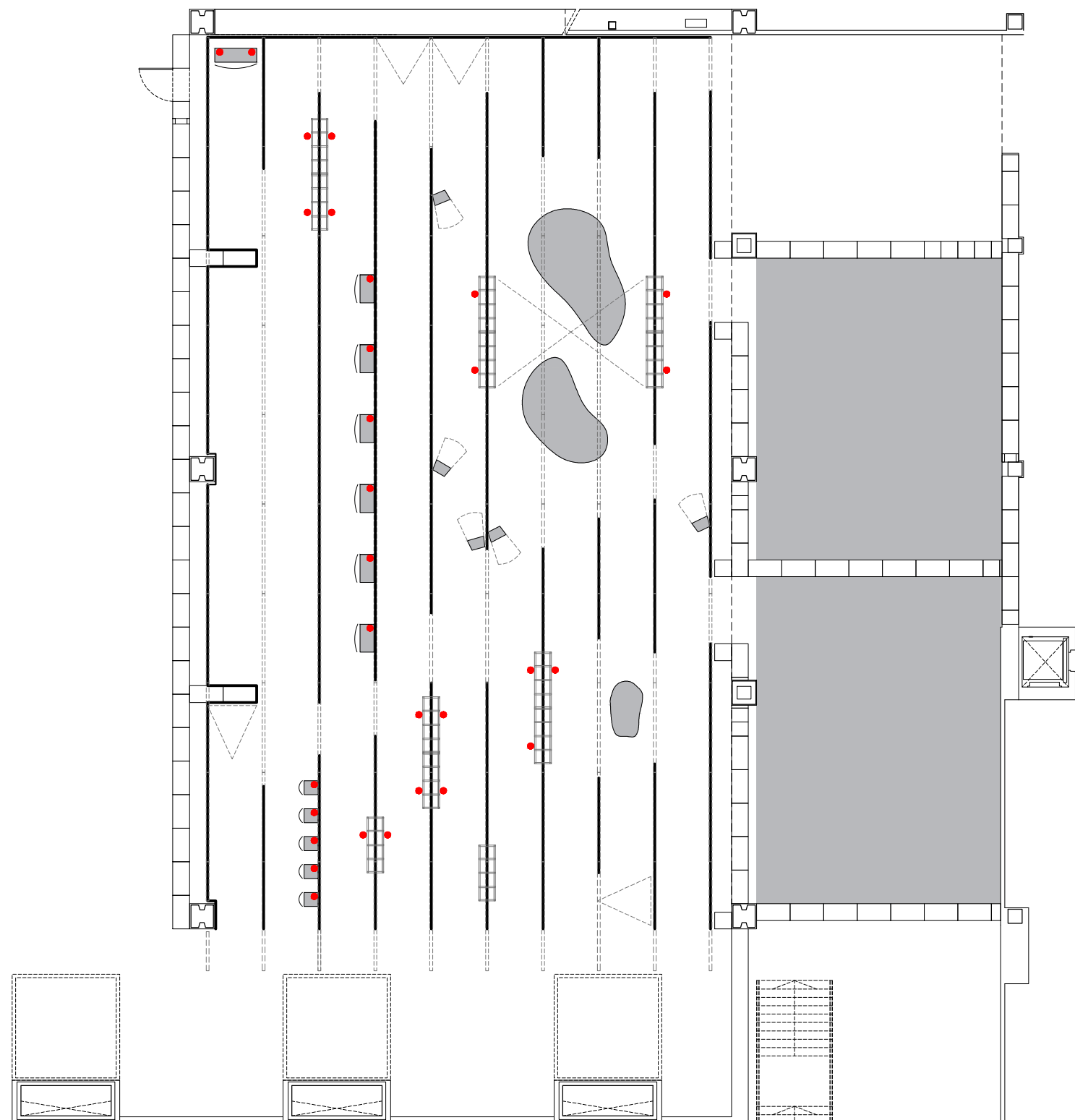

● PUNTO DE LUZ LED INCORPORADO AL DISPOSITIVO

ILUMINACIÓN: DISPOSITIVOS  
PLANTA

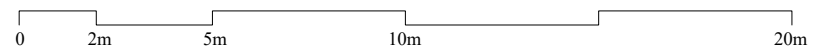

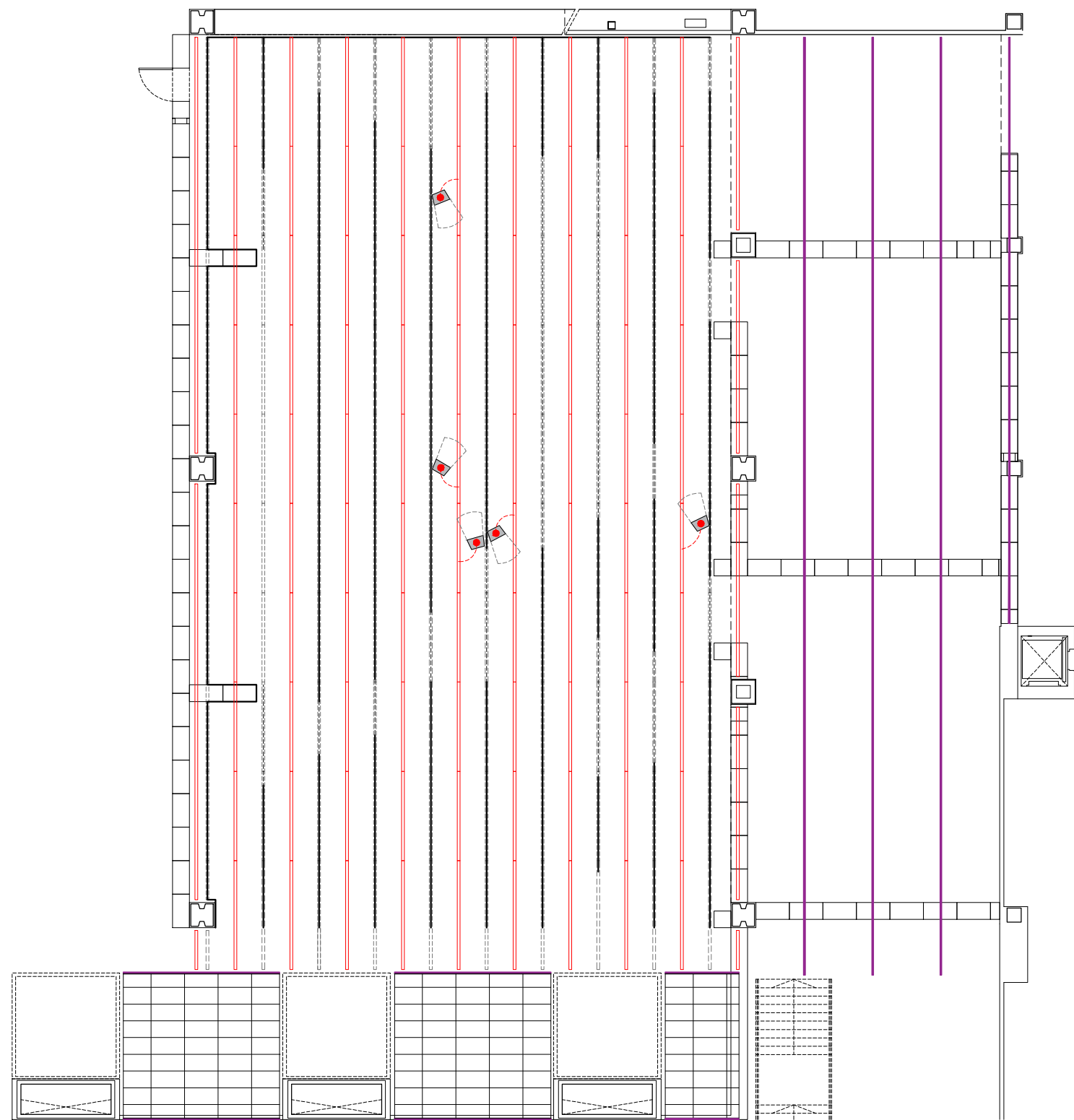

— PERFIL OMEGA CON CARRIL ELECTRIFICADO  
— CARRIL ELECTRIFICADO  
● PANTALLA A CARRIL ELECTRIFICADO

ELECTRICIDAD: TECHO  
PLANTA

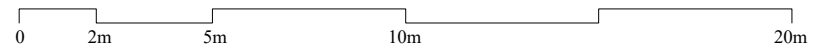

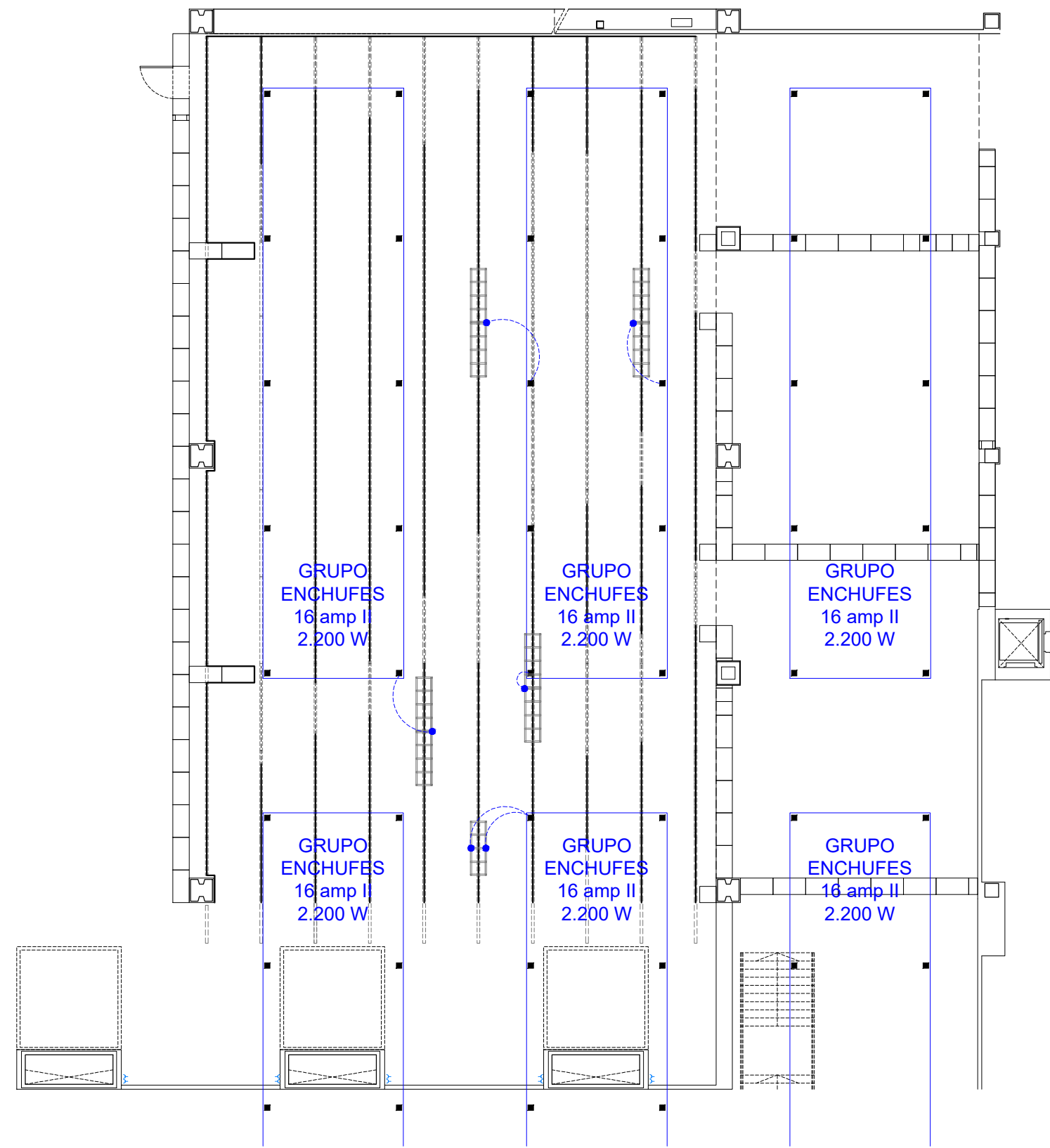

GRUPO  
ENCHUFES  
16 amp II  
2.200 W

GRUPO  
ENCHUFES  
16 amp II  
2.200 W

GRUPO  
ENCHUFES  
16 amp II  
2.200 W

GRUPO  
ENCHUFES  
16 amp II  
2.200 W

GRUPO  
ENCHUFES  
16 amp II  
2.200 W

GRUPO  
ENCHUFES  
16 amp II  
2.200 W

- CAJA A SUELO CON ENCHUFES SCHUKO
- PANTALLA A GRUPO DE ENCHUFES SCHUKO

ELECTRICIDAD: SUELO  
PLANTA

